











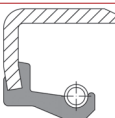
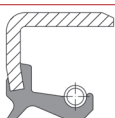
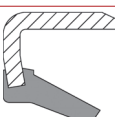

## **Rotary Shaft Seals Product Guide**

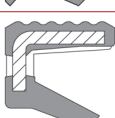
where distributors go – [www.anyseals.com](http://www.anyseals.com) – [shop.anyseals.com](http://shop.anyseals.com)

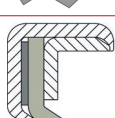
## Oil Seals

Design	anyseals	Simrit	Trelleborg	Forsheda Stefa	Dichtomatik	Taiwan China	Chicago Rawhide CR/SKF	National
	OS-A10	BA	TRA	CB	WA	SC	HMS4	35
	OS-A11	BA SL	TRE	CC	WAS	TC	HMSA7	32
	OS-F10				WA FKM	SF		
	OS-F11				WAS FKM	TF		
	OS-B10	B1	TRC	BB	WB	SB	CRW1	48
	OS-B11	B1 SL	TRD	BC	WBS	TB	CRWA1	47
	OS-B12	B1 OF	"TRG"	"BD"	WBO	VB	HM14	44
	OS-C10	B2	TRB	DB	WC	SA	CRWH1	45
	OS-C11	B2 SL	TRF	DC	WCS	TA	CRWH1	41
	OS-G12		TRK	CD	WAO	VG		
	OS-N21	BABSL	"TRU"		WASY			
	OS-PA31	B2PT						

## V-Rings

Design	anyseals	Simrit	Trelleborg	Forsheda Stefa	Dichtomatik	Taiwan China	Chicago Rawhide CR/SKF	National
 VR-A10			VA	A	VA	VA		
 VR-S10			VS	S	VS	VS		
 VR-L10			VL	L	VL	VL		

## Axial Seals

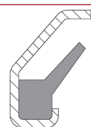
Design	anyseals	Simrit	Trelleborg	Forsheda Stefa	Dichtomatik	Taiwan China	Chicago Rawhide CR/SKF	National
 AS-10		MSC 01	TBP	RB	VRM01	RE		
 AS-11		MSC 02	TBR	9RB	VRM02	RE1		



## Radial Seals

Design	anyseals	Simrit	Trelleborg	Forsheda Stefa	Dichtomatik	Taiwan China	Chicago Rawhide CR/SKF	National
 RD-10		M 15	Roto Glyd Ring® I.D.		RPORI32	VA		
 RD-11		M 16	Roto Glyd Ring® O.D.		RPORA32	VS		
 RD-14		9489	Roto Variseal®		MA47	VL		

## Cover Seals

Design	anyseals	Simrit	Trelleborg	Forsheda Stefa	Dichtomatik	Taiwan China	Chicago Rawhide CR/SKF	National
	CS-10	GA	YJ38	VK	VER	EC		

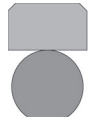
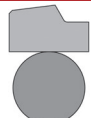
## Piston Seals 1/2

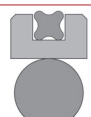
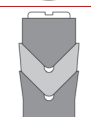
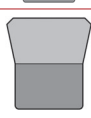
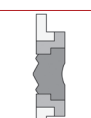
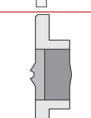
Design	anyseals	Simrit	Trelleborg	Parker	Dichtomatik	Taiwan China	Chicago Rawhide CR/SKF	National
	PS-10	OMK-MR	Glyd Ring®	OE	KPOR30			
	PS-11	OMK-E	Stepseal® K	OG	KPOR31			
	PS-12	TRMA		OA	KO4			
	PS-13		DOUBLE DELTA®	CP	K23			
	PS-19		AQ-Seal®					
	PS-20	EK	CH/G1	M4	KDS01			
	RP-30	S8	Balsele B		KN05 KN06			
	PS-40	L43	DAS DBM	ZX	KK03			
	PS-44	Simko 320 X2	DPS		KK22			

## Piston Seals 2/2

Design	anyseals	Simrit	Trelleborg	Parker	Dichtomatik	Taiwan China	Chicago Rawhide CR/SKF	National
	PS-50	TDUO TDUOH			K15 K17			
	PS-51	TDUO P	AK	DK	K18			
	PS-72	NA300	PUA	B7	KNA28 KNA23			
	RP-70	AUN 100 N 100		GD	KN25 EL2001			
	PS-87	FOA	Variseal® M	JK	KNA44			
	PS-89		Variseal® H	NAA				





## Rod Seals

Design	anyseals	Simrit	Trelleborg	Parker	Dichtomatik	Taiwan China	Chicago Rawhide CR/SKF	National
	RS-10		Glyd Ring®	ON	SPOR30			
	RS-11	OMS-MR	Stepseal® K	OD	SPOR31			
	RS-12	TFMI			S06			
	RS-13		DOUBLE DELTA®	CR	S23			
	RS-20	ES	CH/G5	M2	SDS01 3/2			
	RP-30	S8	Balsele B		KN05 SN05			
	RS-31		Balsele B/NEI		SNI07			
	RS-72	T20 "NI300"	RUO	B3	SNI30 SNI24			
	RP-70	AUN 100 N 100		GD	SN25 SN21			
	RS-87	FOI	Variseal® M	JS	SNI43			
	RS-89		Variseal® H	NAA				

## Wipers

Design	anyseals	Simrit	Trelleborg	Parker	Dichtomatik	Taiwan China	Chicago Rawhide CR/SKF	National
	WS-10	P6 PU6 AUASOB	WRM	A5	AE40 AE42			
	WS-11	ASOB	ASW	A1	AE41 AE47			
	WS-D14	P8	DA17		AD51			
	WS-D15	P9 PU11	DA22	AY	AD53 AD48			
	WS-20	AS	WSA	AM	AM43			
	WS-21	P7 PU7			AM45			
	WS-22	AUAS	WRM/PC		AM44			
	WS-23	AUPS	SWP	"AF"	AM54			
	WS-D24				ADM55			
	WS-30		Excluder®	AT	A80			
	WS-D31		Excluder® 2	AD	AD60			
	WS-D32		Excluder® 5		AD61			

## Guiding elements

Design	anyseals	Simrit	Trelleborg	Parker	Dichtomatik	Taiwan China	Chicago Rawhide CR/SKF	National
	GS-10	KF SF	Slydring®	F3	FB01 FB05			
	GS-11	KF SF	Slydring®	F3	FB01 FB05			
	GR-P10	FRA KB	Slydring®	FP FR	FRK01 FRK05			
	GR-R10	FRI SB	Slydring®	FP FR	FRS01 FRS05 FRS06			

## Bonded Seals

Design	anyseals	Simrit	Trelleborg	Parker	Dichtomatik	Taiwan China	Chicago Rawhide CR/SKF	National
	BS-10	Usit-Ring U	U-Seal GM500		US			
	BS-11	Usit-Ring USF	GM500 selbstz.		USS			

## Flange Seals

Design	anyseals	Simrit	Trelleborg	Parker	Dichtomatik	Taiwan China	Chicago Rawhide CR/SKF	National
	FS-10			JG	MA45			
	FS-11			JF	MA46			

# Content

- 11**  **anyseals - the place where distributors go**  
anyseals is consistently focused on the demands and requirements of the technical trade.
- 12**  **Rotary Shaft Seals**  
**Description.** Shaft seals are rotary seals. They are used to seal rotating or swivelling machine elements.
- 13**  **Norms and quality**  
The design of the shaft seals is based on the German norm DIN 3760.
- 14**  **Functional principle, sealing theory**  
A variety of factors surrounding the sealing system is responsible for the reliable functioning of the shaft seal.
- 18**  **Materials**  
Selecting the correct material combination for a shaft seal is decisive for its reliable functioning and durability.
- 23** **Standard types**  
Detailed description of features, materials, application parameters, shaft and housing design, installation.
- 35** **Special types**  
Detailed description of features, materials, application parameters, shaft and housing design, installation.
- 61**  **Installation, housings, design**  
For a long lifespan of sealing systems, the accurate design of the shaft in the contact surface area is decisive. The reliable functioning of a shaft seal depends on the correct installation.
- 68**  **Operating parameters**  
Peripheral speed (rotational speed), temperature, pressure, support rings, media to be sealed . . .
- 75**  **Storage of Elastomers**  
The optimum storage conditions for Elastomer products are described in DIN 7716 and ISO 2230.
- 76**  **Product range**  
The greatest possible availability – the **anyseals** warehouse

# anyseals - where distributors go

## anyseals is different!

anyseals' mission is to **exclusively serve the distribution market** by maintaining one of the most comprehensive stocking programs for seals.

### Our service at your disposal

For us it is simple - if it's a standard industrial seal that the market needs then we will stock it. The distribution channel is faced with the demand for the appropriate seal in different quantities at the time it is needed. We are the go to place - here to help you find the seal you need and provide the availability that your customers demand. Our specialised team brings passion and years of expertise in order to be the perfect partner for the needs of the seals distribution market.

### Extensive stock availability

We have built our extensive assortment of rotary shaft seals, v-rings, hydraulic seals, wipers, end caps and U-cups that serve the needs of your customers. With more than 15'000 SKUs in imperial and metric dimensions in these ranges only, we clearly aim to carry the dynamic seal inventory that will support you to serve the end customer.

### Technical support

This oil seal guide provides a technical introduction, guide and overview for our radial shaft seal program. Further extensive technical information and information about availability can be found at [www.anyseals.com](http://www.anyseals.com) and in our **e-shop**, the one-stop shop for distributors. Alternatively call us and let us help you find the product you need.

In addition to the extensive oil seal program we also carry O-rings in 50 different compounds in AS-568 inch sizes as well as a very wide metric program to provide an one-stop shop for the distributor market. Whether it's an O-ring with NSF drinking water approvals or a FKM 90 durometer with oil field application approvals (API, NACE or NORSOK) we have it on stock. With 400 million seals in 65'300 SKUs from stock 24/7 365 we are sure to have what you need.



# Rotary Shaft Seals

## Description

Shaft seals are rotary seals. They are used to seal rotating or swivelling machine elements (mainly shafts). The areas of application are diverse and can be found in all areas of mechanical and apparatus engineering.

## Typical applications

- Engine and gear manufacturing
  - Industrial gears
  - Gear engines
  - Electric motors
  - Internal combustion engines
- Pumps
- Drive systems
  - Agricultural machines
  - Construction machines
- Household appliances
  - Washing machines (household and industrial)
  - Dishwashers
- Heavy industry machines
  - Rolling mills
  - Ship building
  - Wind power generators

## Demands made on shaft seals

- Leakage-free sealing under all operating conditions
- Low friction, low power loss, little heat development
- Simple installation, easy replacement

In most applications, the shaft seal is required to hold back a lubricating medium within the space to be sealed. At the same time, the demand can be to prevent the intrusion of dirt, dust, etc. into the space to be sealed. Shaft seals best fulfil these tasks and are therefore the most frequently used sealing elements.

## The structure of a shaft seal is characterised by:

- an elastomer part, sealing lip, or protective lip, if applicable
- outer diameter, and coating of the metal case (reinforcing ring)
- a metal case,
- a spring.

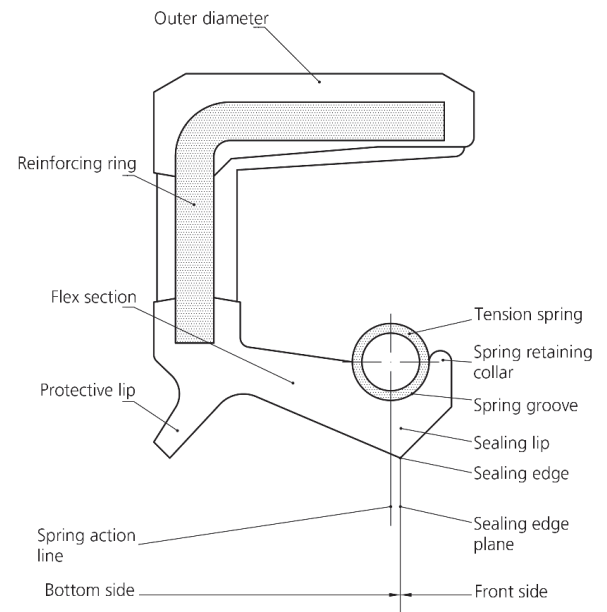

## Shaft seal terminology

Type OS-A11 with elastomer outer diameter, sealing lip, spring and protective lip

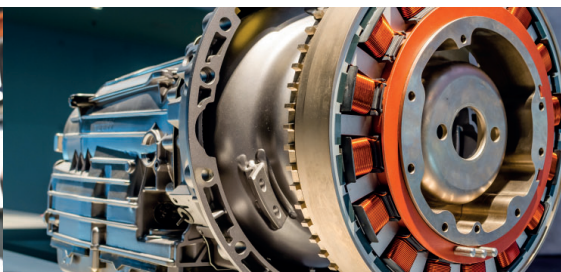

# Norms and quality

## Norms

The design of the shaft seals is based on the German norm DIN 3760.

Internationally, ISO 6194 is also applied.

The usual designation of a shaft seal includes the type, the shaft diameter, the outer diameter, the height and the material:

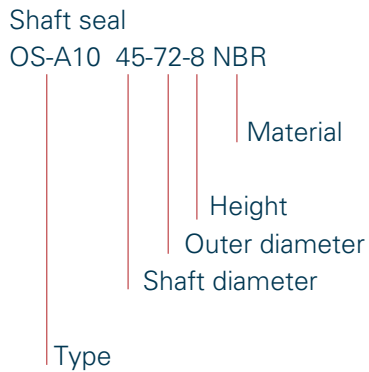

## Quality

Our shaft seals are manufactured to strict quality demands in all areas, from the development, the procurement of source materials to the processing and despatch.

Modern manufacturing methods, many years of experience, strict testing and continuous documentation of all steps guarantee the fulfilment of our own quality demands and particularly those of our customers.

The quality of the products is under constant control for compliance with common international norms and standards.

The following delivery quality applies to all standard shaft seals for which no other arrangement has been made:

Shaft seals according to DIN 3760  
Acceptable quality levels AQL 1.5 according to DIN ISO 2859-1

Customer-specific quality requirements can be agreed individually under purchase orders.

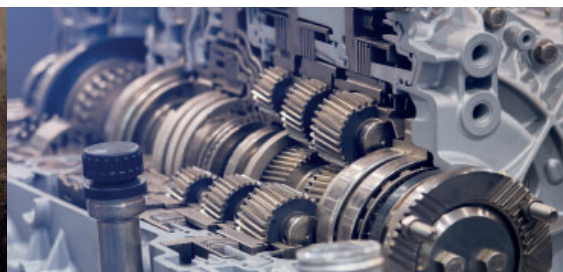

# Functional principle, sealing theory

A variety of factors surrounding the sealing system is responsible for the reliable functioning of the shaft seal. The whole sealing system, comprised of the shaft seal, shaft, housing, medium, environmental and operating conditions, determines the functioning and durability of the seal.

## The shaft seal performs 2 sealing tasks:

- The static sealing between the housing bore and the outer diameter of the seal; which simultaneously guarantees a secure and tight fit of the seal in the housing.
- The dynamic sealing between the sealing edge of the shaft seal and the shaft surface. (When the shaft stops, the sealing is also static.)

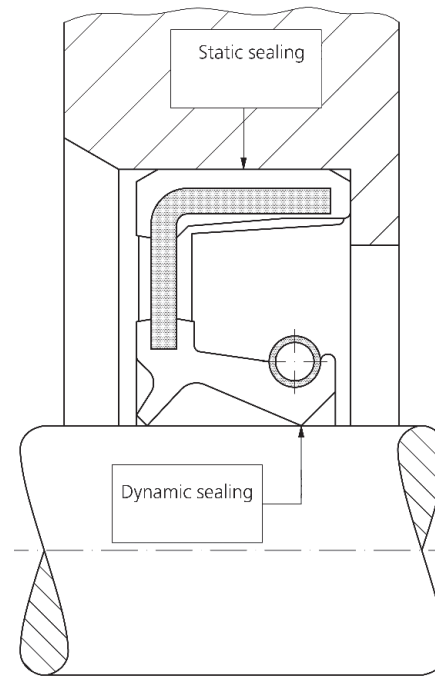

## Static sealing

The static sealing between the housing bore and the outer diameter of the shaft seal is achieved by an oversize of the outer diameter of the seal. (see tables + characteristics)

The prescribed fitting and lead-in chamfers determine the design of the seal and the installation space in such a way that a good compromise between simple installation and static sealing is obtained.

The press fit allowance is the dimension by which the outer diameter of the shaft seal is larger than the nominal dimension of the housing bore.

Outer-Ø D	Permitted diameter difference (out-of-roundness) for outer diameter D
up to 50	0.25
over 50 up to 80	0.35
over 80 up to 120	0.5
over 120 up to 180	0.65
over 180 up to 300	0.8
over 300 up to 500	1.0

The diameter difference ( $D_{\max} - D_{\min}$ ) is obtained from 3 or more measurements distributed equally on the circumference.

## Press fit allowance of the shaft seal outer diameter

Outer-Ø D	Press fit allowance		
	Types acc. to DIN type A	Types acc. to DIN type A + ribbing	Types acc. to DIN type B & C
up to 50	Elastomer outer shell, smooth	Elastomer outer shell, ribbed	Outer shell metal
	+0.30	+0,40	+0.20
over 50			
	+0.15	+0,20	+0.10
up to 80			
	+0.35	+0,45	+0.23
over 80			
	+0.20	+0,25	+0.13
up to 120			
	+0.35	+0,45	+0.25
over 120			
	+0.20	+0,25	+0.15
up to 180			
	+0.45	+0,55	+0.28
over 180			
	+0.25	+0,30	+0.18
up to 300			
	+0.45	+0,55	+0.30
over 300			
	+0.25	+0,30	+0.20
bis 500			
	+0.55	+0,65	+0.35
	+0.30	+0,35	+0.23

# Versions of outer diameters

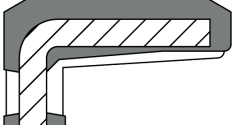
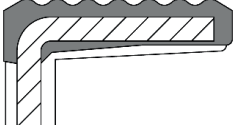
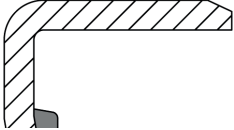
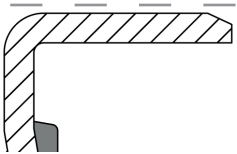
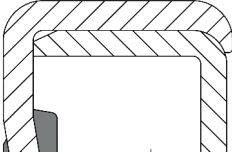
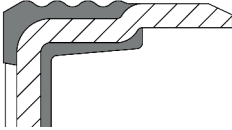
Sketch	Design	Characteristics of the outer diameter versions A, B, C
	Rubber-covered outer diameter, smooth (as in <b>type A</b> DIN 3760)	
	Rubber-covered outer diameter, ribbed (as in <b>type A</b> , DIN 3760 + wave profile)	In addition to the properties of the smooth version: best static sealing on the outer diameter due to higher press fit allowance, for ease of installation, spring back and skew of the seal after press-in is avoided
	Metal outer diameter (as in <b>type B</b> , DIN 3761)	very tight and exact fit in the housing due to metal/metal press fit, care should be taken in connection with light metal housings, housings with increased surface roughness and pressure applications: sealing aids on outer diameter can be used, if necessary.
	Metal outer diameter, lacquered (as in <b>type B</b> , DIN 3761)	
	Metal outer diameter + reinforcing cap (as in <b>type C</b> , DIN 3761)	insensitive to rough or wrong installation, larger sizes provide more rigidity
	Partially rubber-covered outer diameter, (combination of <b>type A</b> <b>and B</b> )	combines the very good static sealing of type A with the tight fit in the housing of type B

# Dynamic sealing

When the shaft rotates, a hydrodynamic sealing mechanism is established in the contact zone between the sealing edge and the shaft. The geometry of the sealing lip, the sealing lip material and the surface structure of the shaft are essential for the sealing mechanism.

## Important design features of the sealing lip are:

- front-side sealing lip angle  
steep angle at the medium side
- bottom-side sealing lip angle  
flat angle at the air side
- Length and thickness of the sealing lip  
influence the flexibility of the sealing lip, from suitability for true running and offset deviation (long, flat profile) to pressure loadable sealing lips (short, high profile)
- Spring position  
Slight axial inside displacement of the spring action line in relation to the plane of the sealing edge (see figure description shaft seal)
- Interference of sealing lip  
The inside diameter of the seal before installation is smaller than the outer diameter of the shaft. The sealing lip is stretched accordingly during installation.
- Radial force of the sealing lip  
The resilience of the sealing lip resulting when the sealing lip is stretched during installation acts as ring-shaped pressure on the shaft surface. This radial force is composed of both the tensile and bending stresses in the elastomer and the expansion of the tension spring.

With increasing rotation of the shaft, from the state of static friction to mixed friction, a hydrodynamic sliding state is created. This causes the sealing edge to float and a very thin sealing gap filled with lubricant (medium) is created. The lubricant in the sealing gap performs the essential task of lubricating and cooling the sealing area. The lubricant that fills the sealing gap is returned to the system by a micro-pump action and does not escape to the air side of the seal as leakage.

The micro-pump effect is produced by the non-symmetrical distribution of the contact pressure in the sealing gap, resulting from the different sealing lip angles and the radial force of the seal.

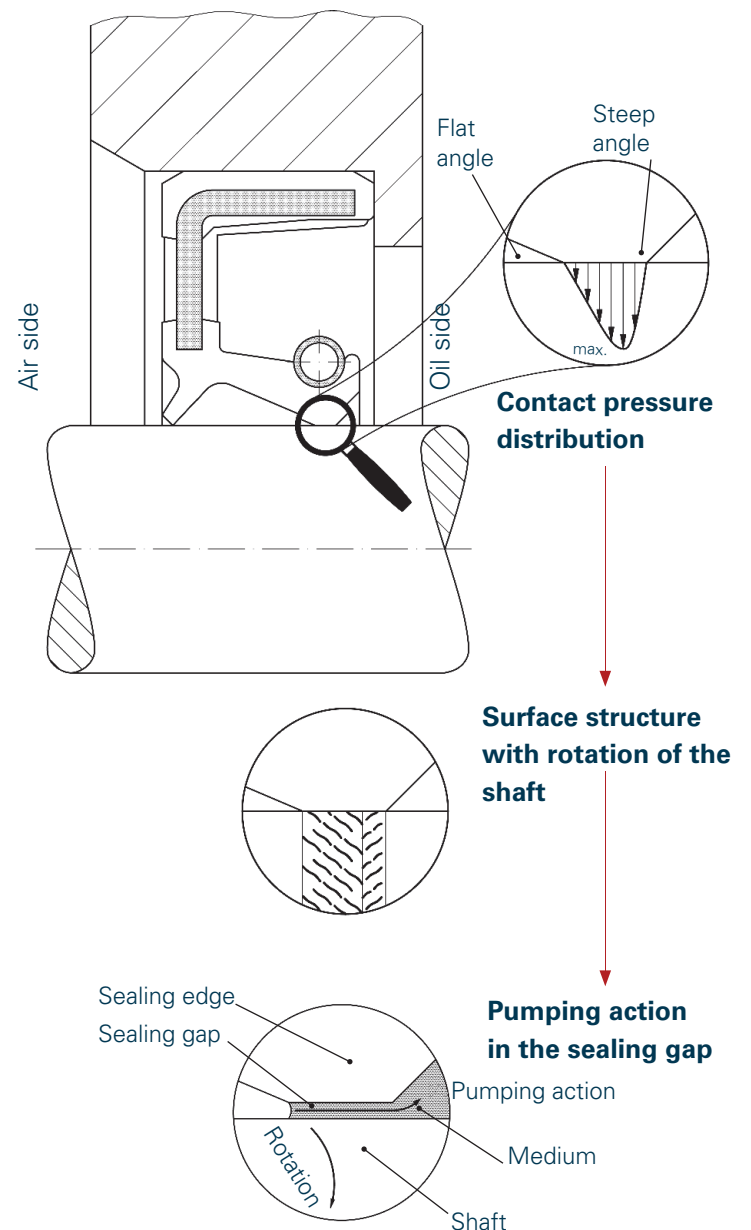

At the start of rotation the elastomer in the contact zone of the sealing edge is deformed in the direction of rotation. A surface structure of many small depressions and protrusions (known as microasperities) running at a slant in the direction of rotation is created. The medium circulating in the sealing gap with the shaft is deflected by these structures. As a result of the non-symmetrical distribution of the contact pressure more structures face towards the medium side than to the air side, causing a total pumping effect in the direction of the medium side.

# Hydrodynamic sealing aids, helix

As a special design, shaft seals can be provided with a so called helix on the bottom side of the sealing lip. When the medium from under the sealing edge reaches the bottom side, the helix with the rotation of the shaft assists the return feeding and thus the hydrodynamic sealing effect.

Running diagonally to the sealing lip, elevated helix ribs lead any medium which may have reached the bottom side to the sealing edge and under it back to the space to be sealed.

Shaft seals with this helix create an increased pumping effect and can, therefore, still guarantee the required sealing effect under aggravated operating conditions such as slightly damaged shaft surfaces or increased eccentricity.

The various helix types are divided into single helix and bidirectional helix.

Shaft seals with a single helix are suitable for only one rotational direction of the shaft, and are referred to as clockwise or anticlockwise.

Shaft seals with a bidirectional helix are suitable for shafts with alternating rotational direction.

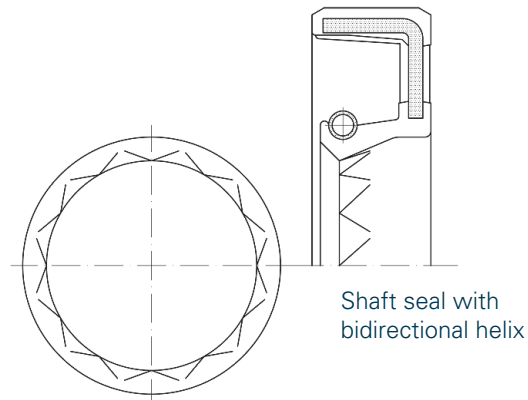
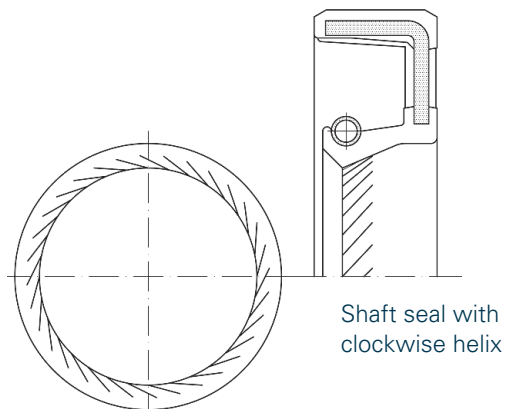
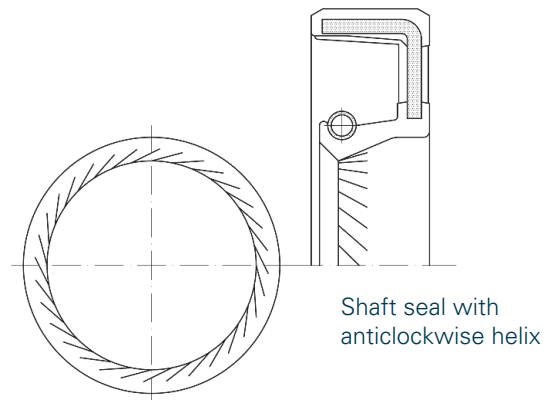

# Materials

## Wide range of materials

Selecting the correct material combination for a shaft seal is decisive for its reliable functioning and durability. For this reason we have various standard materials and a great number of special materials for the elastomer part, the spring and the reinforcing ring to offer.

The standard materials are designed to cover a wide application range and for the large majority of applications, are available directly from stock. For applications with special demands, we can offer you special materials which, due to their composition, are customised to fulfil your requirements. Should there actually be an application for which no existing material composition is suitable, we will be happy to develop a suitable combination for you (minimum quantity given).

## Production

The production of the materials is carried out according to predetermined, strictly monitored production processes and enables the complete traceability from the end product back to the first production step.

The decisive part of a shaft seal is the elastomer part. The term "elastomer" has its origin in the elasticity of the rubber material which can be deformed without much pressure but immediately reverts to its original shape when released. The basis of these elastomers is caoutchouc. Caoutchouc can be obtained as natural caoutchouc on plantations or as is customary for shaft seals today almost exclusively from synthetic rubber in the chemical industry.

To meet the different requirements on modern sealing materials, apart from various basic rubber materials, there are also many varying compounds. Each mixture follows a specific, defined and controlled recipe and consists, in addition of the basic caoutchouc, of fillers, softeners, vulcanizers, processing auxiliaries and other additives.

In a moulding process, the so-called vulcanisation, the finished shaft seal is produced from the rubber compound. The plastic rubber put into a mould tool on a press and subjected to pressure and heat is transformed into elastic rubber material and bonded with the reinforcing ring. The dynamic sealing edge is either ready moulded or is done afterwards in a trimming process. The last production step is the insertion of the spring in the spring groove

## Overview of the materials nomenclature

### Chemical designation of the basic polymer

	Abbreviation acc. to	
	DIN ISO 1629	ASTM D 1418
Acrylonitrile-butadiene rubber	NBR	NBR
Fluoro rubber	FKM	FKM
Ethylene propylene diene rubber	EPDM	EPDM
Silicone rubber	VMQ	VMQ
Hydrogenated acrylonitrile-butadiene rubber	HNBR	HNBR
Polyacrylate rubber	ACM	ACM
	<b>DIN EN ISO 11043-1</b>	<b>ASTM D 1600</b>
Polytetrafluoroethylene	PTFE	PTFE

# General descriptions of the materials

## Acrylonitrile-butadiene rubber – NBR

Among standard seals such as O-rings and radial shaft seals, NBR is the most widely used material. The reasons for this are good mechanical properties, high abrasion resistance, low gas permeability and the high resistance to mineral oil based oils and greases.

NBR is a copolymer of butadiene and acrylonitrile. Depending on the application, the content of acrylonitrile can vary between 18% and 50%. Low ACN content improves cold flexibility at the expense of the resistance to oil and fuel. High ACN content improves the resistance to oil and fuel while reducing the cold flexibility and increasing compression set. To obtain balanced properties, our standard NBR materials have an average ACN content around 30%.

### NBR has good resistance to:

- mineral oil-based oils and greases
- aliphatic hydrocarbons
- vegetable and animal oils and fats
- hydraulic oils H, H-L, H-LP
- hydraulic fluids HFA, HFB, HFC
- silicone oils and silicone greases
- water (max. 80°C)

### NBR is not resistant to:

- fuels with high aromatic content
- aromatic hydrocarbons
- chlorinated hydrocarbons
- non-polar solvents
- hydraulic fluid HFD
- glycol-based brake fluids
- ozone, weathering, ageing

### Application temperature range:

- Standard types -30°C to +100°C (short term 120°C)
- Special grades possible down to -50°C

## Hydrogenated acrylonitrile-butadiene rubber – HNBR

HNBR is obtained by selective hydrogenation of the double bond of the butadiene molecules of the NBR rubber. With higher degrees of hydrogenation HNBR exhibits distinctly better resistance to high temperatures, ozone and ageing as well as improved mechanical properties.

The media resistance of HNBR is the same as that of NBR.

### Application temperature range:

- -30°C to +150°C

## Fluoro rubber – FKM

FKM materials have conquered many applications in which high thermal and / or chemical resistance is required. FKM also has excellent resistance to ozone, weathering and ageing. Very low gas permeability, FKM is recommended for vacuum applications.

### FKM has good resistance to:

- mineral oil-based oils and greases
- aliphatic hydrocarbons
- aromatic hydrocarbons
- chlorinated hydrocarbons
- hydraulic fluids HFD
- vegetable and animal oils and fats
- silicone oils and silicone greases
- fuels
- non-polar solvents
- ozone, weathering, ageing

### FKM is not resistant to:

- glycol-based brake fluids
- polar solvents (e.g., acetone)
- superheated steam
- hot water
- amines, alkalis
- low-molecular organic acids (e.g., acetic acid)

### Application temperature range:

- -15 to +200°C short term +220°C  
down to -35°C is realistic with special grades

# General descriptions of the materials

## Ethylene propylene diene rubber – EPDM

EPDM can be used in a wide temperature range, has good resistance to ozone, weathering and ageing and is resistant to hot water and steam. Peroxide cured EPDM materials have better resistance to temperature and chemicals and obtain better compression set values than sulfur cured EPDM.

### EPDM has good resistance to:

- hot water and hot steam
- many polar solvents (e.g., alcohols, ketones, esters)
- many organic and inorganic acids and bases
- washing brines
- silicone oils and silicone greases
- glycol-based brake fluids (special grades required)
- ozone, weathering, ageing

### EPDM is not resistant to:

- all kinds of mineral oil products (oils, greases, fuels)

### Application temperature range:

- -45°C to +130°C (sulfur cured)
- -55°C to +150°C (peroxide cured)

## Silicone rubber – VMO

Silicone materials have excellent aging resistance, oxygen, ozone, ultraviolet radiation and weathering and a very wide application temperature range with excellent cold flexibility. Silicone is physiologically harmless and therefore very good in food and medical product applications. Silicone has good electrical insulation properties and is highly permeable to gas. Due to the weak mechanical properties, silicone O-rings are preferably used in static.

### Silicone has good resistance to:

- animal and vegetable oils and fats
- water (max. 100°C)
- aliphatic engine and gear oils
- ozone, weathering, ageing

### Silicone is not resistant to:

- silicone oils and greases
- aromatic mineral oils
- fuels
- steam over 120°C
- acids and alkalis

### Application temperature range:

- -60°C to +200°C
- +230°C can be obtained by special grades

## Acrylate rubber – ACM

ACM has good resistance to mineral oils with additives at higher temperatures. This makes ACM a preferred material in the automotive industry.

### ACM has good resistance to:

- mineral oil-based engine, gear and ATF oils
- ozone, weathering, ageing

### ACM is not resistant to:

- glycol-based brake fluids
- aromatic and chlorinated hydrocarbons
- hot water, steam
- acids and bases

### Application temperature range:

- -20°C to +150°C

## Polytetrafluoroethylene - PTFE

PTFE is a fluorinated thermoplastic material with many very positive characteristics for a sealing material. These include its very high thermal and almost unlimited chemical resistance. Of all the sealing materials described here, PTFE has the lowest friction coefficient, which commends the material for dynamic applications.

The pure PTFE material without fillers is physiologically safe and for this reason is also used in food-related applications and in medical technology.

PTFE with fillers is used for shaft seals.

Our type OS-W50 is produced as a complete turned piece made from PTFE carbon/graphite.

The OS-PA30. 31 and 32 types are provided with a clamped sealing lip made from PTFE glass fibre//MoS<sub>2</sub>. Elastomer shaft seals can be provided with a thin PTFE film on the sealing lip to reduce friction (application e.g. car racing).

### Application temperature range:

- -90°C to +250°C

# Materials for shaft seals

## Standard-materials for shaft seals

Material	Types	Hardness [Shore A]	Hardness [Shore D]	Colour	Application temperature range [°C]
NBR	Standard with elastomer sealing lip	70	-	black	-40 to +100
FKM	Standard with elastomer sealing lip	80	-	brown	-25 to +200
NBR	OS-N21	80	-	blue	-30 to +100
NBR	OS-G12	70	-	green	-40 to +100
PTFE carbon/graphite	OS-PA31	-	-	grey	-90 to +250

## Special materials for shaft seals

Material	Types	Hardness Shore A]	Colour	Application temperature range [°C]
NBR anti-friction graphite	for all types with elastomer sealing lip, on request	70	black	-40 to +100
NBR anti-friction MoS2		70	black	-40 to +100
NBR high nitrile		70	black	-30 to +100
NBR low-temperature grade		70	black	-50 to +90
HNBR		70	black	-40 to +130
Silicon VMQ		70	red	-55 to +200
ACM		70	black	-20 to +150
EPDM		70	black	-40 to +140

We will be happy to offer you other material compounds in different hardnesses, colours and compositions, on request.

# Materials for springs

## Spring materials

Type	Material		
	Unalloyed spring steel wire according to DIN EN 10270-1	Stainless steel 1.4301 (SAE 30304)	Stainless steel 1.4571 (SAE 30316)
Standard	X	on request	on request
OS-F10 in FKM OS-F11 in FKM	–	X	on request
OS-W50 OS-W51	–	–	X

On request standard shaft seals can also be provided with stainless steel springs.

## Application of spring materials

Medium	Material		
	Unalloyed spring steel wire according to DIN EN 10270-1	Stainless steel 1.4301 (SAE 30304)	Stainless steel 1.4571 (SAE 30316)
Oils and greases	X	X	X
Water	–	X	X
Salt water	–	–	X

## Case materials

Bauforn	Werkstoff		
	Unalloyed steel according to DIN EN 10139	Stainless steel 1.4301 (SAE 30304)	Stainless steel SAE 30316
Standard	X	on request	on request
OS-PA30 OS-PA31 OS-PA32	on request	–	X

On request standard types can also be provided with stainless steel cases. Alternatively, the case can be fully covered with elastomer on one side or both sides.

# Standard types

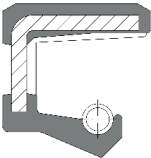
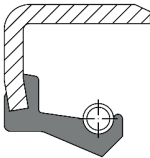
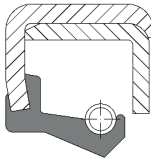
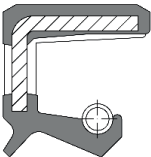
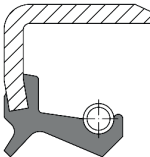
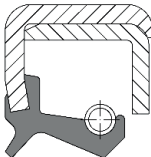
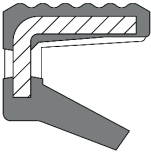
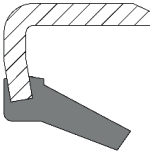
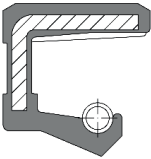
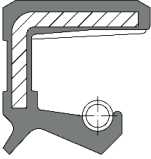
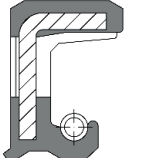
Lip design	Outer diameter		
	Outer diameter elastomer	Metal outer diameter	Metal outer diameter, +reinforcing cap
Sealing lip, spring-loaded	<b>OS-A10</b> 	<b>OS-B10</b> 	<b>OS-C10</b> 
Sealing lip, spring-loaded, + protective lip	<b>OS-A11</b> 	<b>OS-B11</b> 	<b>OS-C11</b> 
Sealing lip, without spring	<b>OS-G12</b> 	<b>OS-B12</b> 	
Sealing lip, spring-loaded, case fully covered with elastomer	<b>OS-F10</b> 		
Sealing lip, spring-loaded, + protection lip case fully covered with elastomer	<b>OS-F11</b> 		
Sealing lip, spring-loaded, + protective lip, pressure loadable (see operating parameters /pressure)	<b>OS-N21</b> 		

# OS-A10

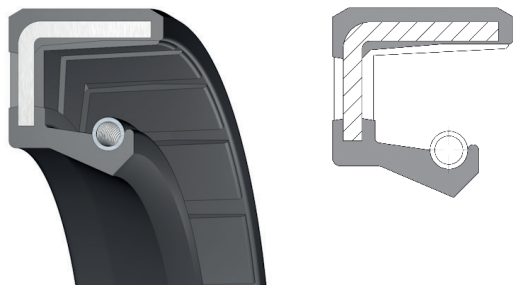

## Description

- Elastomer-coated OD, flat
- Spring loaded sealing lip
- ribbed OD available on request, type

## Special features

- Modern sealing lip design for high dynamic sealing action
- Reliable static sealing inside housing
- For housings with high thermal expansion, e.g., light metal housing
- For split housings
- For housings with increased surface roughness
- For sealing thin-body and gaseous media
- No risk of fretting corrosion

## Applications e.g.:

- Mechanical and apparatus engineering
- Agricultural machinery
- Construction machines
- Drive systems, industrial gearboxes, electric motors

## Materials

### Standard material

Elastomer	NBR 70 black (FKM 80 brown is standard for OS-F10)
Spring	Spring steel according to DIN EN 10270-1
Metal case	Carbon steel according to DIN EN 10139

## Special materials

Elastomer	FKM Silicone ACM HNBR CR EPDM
Spring	Stainless steel 1.4301
Metal case	Stainless steel 1.4301

## Application parameters

for the standard materials combination

Temperature	-40°C to +100°C
Pressure	depressurized, max. 0.05 MPa
Shaft speed	acc. to chart „Operating parameters for rotary shaft seals“
Media	Mineral oil based lubricants, synthetic lubricants

When synthetic lubricants are used for which there is no empirical experience, test the compatibility in the laboratory or - better even - in practical trials. The operating temperature should not exceed 80°C.

## Design information

### Shaft

Tolerance	ISO h11
Hardness	min. 45 HRC
Roughness	$R_a = 0.2 - 0.8 \mu\text{m}$ $R_z = 1 - 5 \mu\text{m}$ $R_{\text{max}} \leq 6.3 \mu\text{m}$
Surface finish	free of orientation (lead free)

### Housing bore

Tolerance	ISO H8
Roughness	$R_a = 1.6 - 6.3 \mu\text{m}$ $R_z = 10 - 20 \mu\text{m}$ $R_{\text{max}} \leq 25 \mu\text{m}$

## Installation

Please read our installation instructions.

# OS-A11

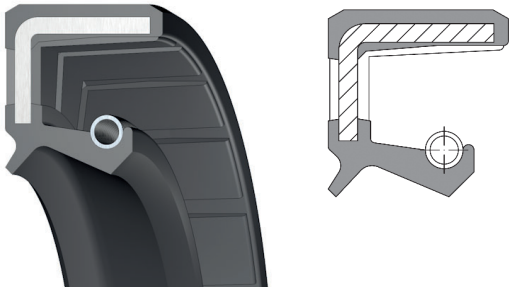

## Description

- Elastomer-coated OD, flat
  - Spring loaded sealing lip
  - Protective lip against entry of contamination from outside (dust, dirt,...)
- ribbed OD available on request, type 1

## Special features

- Modern sealing lip design for high dynamic sealing action
- Reliable static sealing inside housing
- For housings with high thermal expansion, e.g., light metal housing
- For split housings
- For housings with increased surface roughness
- For sealing thin-body and gaseous media
- No risk of fretting corrosion
- Efficient protection against air side contaminations

## Applications e.g.:

- Mechanical and apparatus engineering
- Agricultural machinery
- Construction machines
- Drive systems, industrial gearboxes, electric motors

## Materials

### Standard material

Elastomer	NBR 70 black (FKM 80 brown is standard for OS-F11)
Spring	Spring steel according to DIN EN 10270-1
Metal case	Carbon steel according to DIN EN 10139

## Special materials

Elastomer	FKM Silicone ACM HNBR CR EPDM
Spring	Stainless steel 1.4301
Metal case	Stainless steel 1.4301

## Application parameters

	for the standard materials combination
Temperature	-40°C to +100°C
Pressure	depressurized, max. 0.05 MPa
Shaft speed	acc. to chart „Operating parameters for rotary shaft seals“
Media	Mineral oil based lubricants, synthetic lubricants

When synthetic lubricants are used for which there is no empirical experience, test the compatibility in the laboratory or - better even - in practical trials. The operating temperature should not exceed 80°C.

## Design information

### Shaft

Tolerance	ISO h11
Hardness	min. 45 HRC
Roughness	$R_a = 0.2 - 0.8 \mu\text{m}$ $R_z = 1 - 5 \mu\text{m}$ $R_{\text{max}} \leq 6.3 \mu\text{m}$
Surface finish	free of orientation (lead free)

### Housing bore

Tolerance	ISO H8
Roughness	$R_a = 1.6 - 6.3 \mu\text{m}$ $R_z = 10 - 20 \mu\text{m}$ $R_{\text{max}} \leq 25 \mu\text{m}$

## Installation

Please read our installation instructions.

# OS-F10

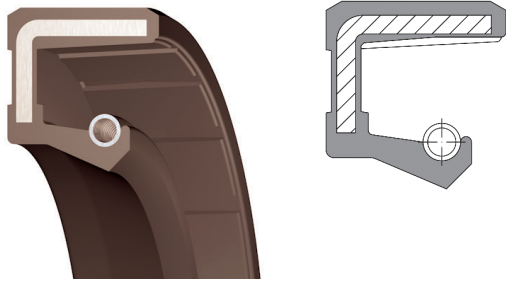

## Description

- Elastomer-coated OD, flat
- Spring loaded sealing lip (stainless steel spring)
- Metal case fully covered with elastomer

## Special features

- Corrosion-protected metal case
- The standard materials combination (FKM + stainless steel spring) is suitable for many media and chemicals and for high shaft speeds and high temperatures
- Modern sealing lip design for high dynamic sealing action
- Reliable static sealing inside housing
- For housings with high thermal expansion, e.g., light metal housing
- For split housings
- For housings with increased surface roughness
- For sealing thin-body and gaseous media
- No risk of fretting corrosion

## Applications e.g.:

- Mechanical and apparatus engineering
- Agricultural machinery
- Construction machines
- Drive systems, industrial gearboxes, electric motors

## Materials

### Standard material

Elastomer	FKM 80 brown
Spring	Stainless steel 1.4301
Metal case	Carbon steel according to DIN EN 10139

## Special materials

Elastomer	NBR
	Silicon
	ACM
	HNBR
	CR
	EPDM

## Application parameters

For the standard materials combination:

Temperature	-25°C to +160°C
Pressure	depressurized, max. 0,05 MPa
Shaft speed	acc. to chart „Operating parameters for rotary shaft seals“
Media	Mineral oil based lubricants, Synthetic lubricants, Fuels, Aromatic and chlorinated hydrocarbons, Good resistance to many chemicals

## Design information

### Shaft

Tolerance	ISO h11
Hardness	min. 45 HRC
Roughness	$R_a = 0.2 - 0.8 \mu\text{m}$ $R_z = 1 - 5 \mu\text{m}$ $R_{\text{max}} \leq 6.3 \mu\text{m}$
Surface finish	free of orientation (lead free)

### Housing bore

Tolerance	ISO H8
Roughness	$R_a = 1.6 - 6.3 \mu\text{m}$ $R_z = 10 - 20 \mu\text{m}$ $R_{\text{max}} \leq 25 \mu\text{m}$

## Installation

Please read our installation instructions.

# OS-F11

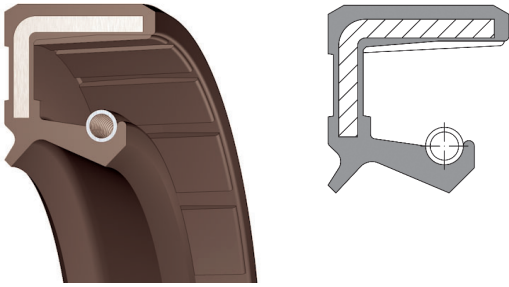

## Description

- Elastomer-coated OD, flat
- Spring loaded sealing lip (stainless steel spring)
- Metal case fully covered with elastomer
- Protective lip against entry of contamination from outside (dust, dirt,...)

## Special features

- Corrosion-protected metal case
- The standard materials combination (FKM + stainless steel spring) is suitable for many media and chemicals and for high shaft speeds and high temperatures
- Modern sealing lip design for high dynamic sealing action
- Reliable static sealing inside housing
- For housings with high thermal expansion, e.g., light metal housing
- For split housings
- For housings with increased surface roughness
- For sealing thin-body and gaseous media
- No risk of fretting corrosion
- Efficient protection against air side contaminations

## Applications e.g.:

- Mechanical and apparatus engineering
- Agricultural machinery
- Construction machines
- Drive systems, industrial gearboxes, electric motors

## Materials

### Standard material

Elastomer	FKM 80 brown
Spring	Stainless steel 1.4301
Metal case	Carbon steel according to DIN EN 10139

## Special materials

Elastomer	NBR
	Silicon
	ACM
	HNBR
	CR
	EPDM

## Application parameters

For the standard materials combination:

Temperature	-25°C to +160°C
Pressure	depressurized, max. 0,05 MPa
Shaft speed	acc. to chart „Operating parameters for rotary shaft seals“
Media	Mineral oil based lubricants, Synthetic lubricants, Fuels, Aromatic and chlorinated hydrocarbons, Good resistance to many chemicals

## Design information

### Shaft

Tolerance	ISO h11
Hardness	min. 45 HRC
Roughness	$R_a = 0.2 - 0.8 \mu\text{m}$ $R_z = 1 - 5 \mu\text{m}$ $R_{\text{max}} \leq 6.3 \mu\text{m}$
Surface finish	free of orientation (lead free)

### Housing bore

Tolerance	ISO H8
Roughness	$R_a = 1.6 - 6.3 \mu\text{m}$ $R_z = 10 - 20 \mu\text{m}$ $R_{\text{max}} \leq 25 \mu\text{m}$

## Installation

Please read our installation instructions.

# OS-B10



## Description

- Metal OD
- Spring loaded sealing lip

## Special features

- Modern sealing lip design for high dynamic sealing action
- Very firm and exact fit inside the housing due to metal-metal interference fit
- Be careful when using the product in connection with light metal housings, housings with increased surface roughness and applications with overpressure:  
Apply sealing aid to the outside diameter if necessary. A version with outside diameter coated with bore sealant is available on request.  
Can be combined with our axial seals AS-10 and V-rings

## Applications e.g.:

- Mechanical and apparatus engineering
- Agricultural machinery
- Construction machines  
Drive systems, industrial gearboxes, electric motors

## Materials

### Standard material

Elastomer	NBR 70 black
Spring	Spring steel according to DIN EN 10270-1
Metal case	Carbon steel according to DIN EN 10139

## Special materials

Elastomer	FKM
	Silicon
	ACM
	HNBR
	CR
	EPDM
Spring	Stainless steel 1.4301
Metal case	Stainless steel 1.4301

## Application parameters

for the standard materials combination	
Temperature	-40°C to +100°C
Pressure	depressurized, max. 0.05 MPa
Shaft speed	acc. to chart „Operating parameters for rotary shaft seals“
Media	Mineral oil based lubricants, synthetic lubricants

When synthetic lubricants are used for which there is no empirical experience, test the compatibility in the laboratory or - better even - in practical trials.  
The operating temperature should not exceed 80°C.

## Design information

### Shaft

Tolerance	ISO h11
Hardness	min. 45 HRC
Roughness	$R_a = 0.2 - 0.8 \mu\text{m}$ $R_z = 1 - 5 \mu\text{m}$ $R_{\text{max}} \leq 6.3 \mu\text{m}$
Surface finish	free of orientation (lead free)

### Housing bore

Tolerance	ISO H8
Roughness	$R_a = 0.8 - 3.2 \mu\text{m}$ $R_z = 6.3 - 16 \mu\text{m}$ $R_{\text{max}} \leq 16 \mu\text{m}$

## Installation

Please read our installation instructions.

# OS-B11

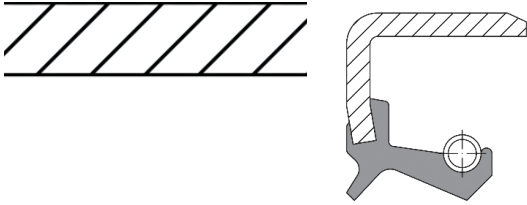

## Description

- Metal OD
- Spring loaded sealing lip
- Protective lip against entry of contamination from outside (dust, dirt,...)

## Special features

- Modern sealing lip design for high dynamic sealing action
- Very firm and exact fit inside the housing due to metal-metal interference fit
- Be careful when using the product in connection with light metal housings, housings with increased surface roughness and applications with overpressure:  
Apply sealing aid to the outside diameter if necessary. A version with outside diameter coated with bore sealant is available on request.
- Can be combined with our axial seals AS-10 and V-rings
- Efficient protection against air side contaminations

## Applications e.g.:

- Mechanical and apparatus engineering
- Agricultural machinery
- Construction machines
- Drive systems, industrial gearboxes, electric motors

## Materials

### Standard material

Elastomer	NBR 70 black
Spring	Spring steel according to DIN EN 10270-1
Metal case	Carbon steel according to DIN EN 10139

## Special materials

Elastomer	FKM
	Silicon
	ACM
	HNBR
	CR
	EPDM
Spring	Stainless steel 1.4301
Metal case	Stainless steel 1.4301

## Application parameters

for the standard materials combination

Temperature	-40°C to +100°C
Pressure	depressurized, max. 0.05 MPa
Shaft speed	acc. to chart „Operating parameters for rotary shaft seals“
Media	Mineral oil based lubricants, synthetic lubricants

When synthetic lubricants are used for which there is no empirical experience, test the compatibility in the laboratory or - better even - in practical trials. The operating temperature should not exceed 80°C.

## Design information

### Shaft

Tolerance	ISO h11
Hardness	min. 45 HRC
Roughness	$R_a = 0.2 - 0.8 \mu\text{m}$ $R_z = 1 - 5 \mu\text{m}$ $R_{\text{max}} \leq 6.3 \mu\text{m}$
Surface finish	free of orientation (lead free)

### Housing bore

Tolerance	ISO H8
Roughness	$R_a = 0.8 - 3,2 \mu\text{m}$ $R_z = 6.3 - 16 \mu\text{m}$ $R_{\text{max}} \leq 16 \mu\text{m}$

## Installation

Please read our installation instructions.

# OS-B12

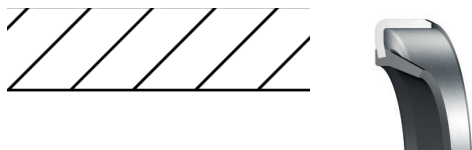

## Description

- Metal OD
- Non-spring-loaded sealing lip

## Special features

- Non-spring-loaded lip design for secondary sealing jobs e.g., grease sealing
- Low friction
- Compact design
- Little installation space
- Firm and exact fit inside the housing
- Be careful when using the product in connection with light metal housings, housings with increased surface roughness and applications with overpressure:  
Apply sealing aid to the outside diameter if necessary. A version with outside diameter coated with bore sealant is available on request.

## Applications e.g.:

- Secondary sealing jobs
- Mechanical and apparatus engineering
- Drive systems  
Electric motors

## Materials

### Standard material

Elastomer	NBR 70 black
Metal case	Carbon steel according to DIN EN 10139

## Special materials

Elastomer	FKM Silicon ACM HNBR CR EPDM
Metal case	Stainless steel 1.4301

## Application parameters

for the standard materials combination

Temperature	-40°C to +100°C
Pressure	depressurized
Shaft speed	max. 6 m/s (and acc. to chart) „Operating parameters for rotary shaft seals“
Media	Mineral oil based lubricants, synthetic lubricants

When synthetic lubricants are used for which there is no empirical experience, test the compatibility in the laboratory or - better even - in practical trials. The operating temperature should not exceed 80°C.

## Design information

### Shaft

Tolerance	ISO h11
Hardness	min. 45 HRC
Roughness	$R_a = 0.2 - 0.8 \mu\text{m}$ $R_z = 1 - 5 \mu\text{m}$ $R_{\text{max}} \leq 6.3 \mu\text{m}$
Surface finish	free of orientation (lead free)

### Housing bore

Tolerance	ISO H8
Roughness	$R_a = 0.8 - 3,2 \mu\text{m}$ $R_z = 6.3 - 16 \mu\text{m}$ $R_{\text{max}} \leq 16 \mu\text{m}$

## Installation

Please read our installation instructions.

# OS-C10

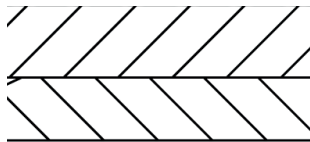

## Description

- Metal OD + reinforcement cap
- Spring loaded sealing lip

## Special features

- Modern sealing lip design for high dynamic sealing action
- Very firm and exact fit inside the housing due to metal-metal interference fit
- Be careful when using the product in connection with light metal housings, housings with increased surface roughness and applications with overpressure: Apply sealing aid to the outside diameter if necessary. A version with outside diameter coated with bore sealant is available on request.
- Resistant to rough or incorrect installation
- Provides more rigidity with larger dimensions
- Can be combined with our axial seals AS-10 and V-rings

## Applications e.g.:

- Mechanical and apparatus engineering
- Agricultural machinery
- Construction machines
- Drive systems, industrial gearboxes, electric motors
- Applications in the heavy industry

## Materials

### Standard material

Elastomer	NBR 70 black
Spring	Spring steel according to DIN EN 10270-1
Metal case	Carbon steel according to DIN EN 10139

## Special materials

Elastomer	FKM
	Silicon
	ACM
	HNBR
	CR
	EPDM
Spring	Stainless steel 1.4301
Metal case	Stainless steel 1.4301

## Application parameters

for the standard materials combination

Temperature	-40°C to +100°C
Pressure	depressurized, max. 0.05 MPa
Shaft speed	acc. to chart „Operating parameters for rotary shaft seals“
Media	Mineral oil based lubricants, synthetic lubricants

When synthetic lubricants are used for which there is no empirical experience, test the compatibility in the laboratory or - better even - in practical trials. The operating temperature should not exceed 80°C.

## Design information

### Shaft

Tolerance	ISO h11
Hardness	min. 45 HRC
Roughness	$R_a = 0.2 - 0.8 \mu\text{m}$ $R_z = 1 - 5 \mu\text{m}$ $R_{\text{max}} \leq 6.3 \mu\text{m}$
Surface finish	free of orientation (lead free)

### Housing bore

Tolerance	ISO H8
Roughness	$R_a = 0.8 - 3,2 \mu\text{m}$ $R_z = 6.3 - 16 \mu\text{m}$ $R_{\text{max}} \leq 16 \mu\text{m}$

## Installation

Please read our installation instructions.

# OS-C11

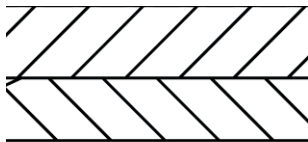

## Description

- Metal OD + reinforcement cap
- Spring loaded sealing lip
- Protective lip against entry of contamination from outside (Dust, dirt,...)

## Special features

- Modern sealing lip design for high dynamic sealing action
- Very firm and exact fit inside the housing due to metal-metal interference fit
- Be careful when using the product in connection with light metal housings, housings with increased surface roughness and applications with overpressure: Apply sealing aid to the outside diameter if necessary. A version with outside diameter coated with bore sealant is available on request.
- Resistant to rough or incorrect installation
- Provides more rigidity with larger dimensions
- Can be combined with our axial seals AS-10 and V-rings
- Efficient protection against air side contaminations

## Applications e.g.:

- Mechanical and apparatus engineering
- Agricultural machinery
- Construction machines
- Drive systems, industrial gearboxes, electric motors
- Applications in the heavy industry

## Materials

### Standard material

Elastomer	NBR 70 black
Spring	Spring steel according to DIN EN 10270-1
Metal case	Carbon steel according to DIN EN 10139

## Special materials

Elastomer	FKM
	Silicon
	ACM
	HNBR
	CR
	EPDM
Spring	Stainless steel 1.4301
Metal case	Stainless steel 1.4301

## Application parameters

for the standard materials combination

Temperature	-40°C to +100°C
Pressure	depressurized, max. 0.05 MPa
Shaft speed	acc. to chart „Operating parameters for rotary shaft seals“
Media	Mineral oil based lubricants, synthetic lubricants

When synthetic lubricants are used for which there is no empirical experience, test the compatibility in the laboratory or - better even - in practical trials. The operating temperature should not exceed 80°C.

## Design information

### Shaft

Tolerance	ISO h11
Hardness	min. 45 HRC
Roughness	$R_a = 0.2 - 0.8 \mu\text{m}$ $R_z = 1 - 5 \mu\text{m}$ $R_{\text{max}} \leq 6.3 \mu\text{m}$
Surface finish	free of orientation (lead free)

### Housing bore

Tolerance	ISO H8
Roughness	$R_a = 0.8 - 3,2 \mu\text{m}$ $R_z = 6.3 - 16 \mu\text{m}$ $R_{\text{max}} \leq 16 \mu\text{m}$

## Installation

Please read our installation instructions.

# OS-G12

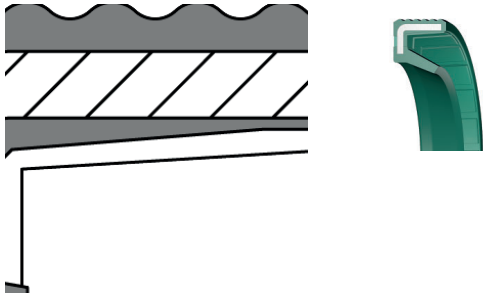

## Description

- Elastomer-coated OD, ribbed
- Non-spring-loaded sealing lip

## Special features

- Non-spring-loaded lip design, for secondary sealing jobs e.g., grease sealing
- Low friction
- Compact design
- Little installation space
- Reliable static sealing inside housing
- For housings with high thermal expansion, e.g., light metal housing
- For split housings
- For housings with increased surface roughness
- No risk of fretting corrosion

## Applications e.g.:

- Secondary sealing jobs
- Mechanical and apparatus engineering
- Drive systems
- Electric motors

## Materials

### Standard material

Elastomer	NBR 70 green
Metal case	Carbon steel according to DIN EN 10139

## Special materials

Elastomer	FKM Silicon ACM HNBR CR EPDM
Metal case	Stainless steel 1.4301

## Application parameters

For the standard materials combination:

Temperature	-40°C to +100°C
Pressure	depressurized
Shaft speed	max. 6 m/s, and acc. to chart „Operating parameters for rotary shaft seals“
Media	Mineral oil based lubricants, synthetic lubricants

When synthetic lubricants are used for which there is no empirical experience, test the compatibility in the laboratory or - better even - in practical trials. The operating temperature should not exceed 80°C.

## Design information

### Shaft

Tolerance	ISO h11
Hardness	min. 45 HRC
Roughness	$R_a = 0.2 - 0.8 \mu\text{m}$ $R_z = 1 - 5 \mu\text{m}$ $R_{\text{max}} \leq 6.3 \mu\text{m}$
Surface finish	free of orientation (lead free)

### Housing bore

Tolerance	ISO H8
Roughness	$R_a = 1.6 - 6.3 \mu\text{m}$ $R_z = 10 - 20 \mu\text{m}$ $R_{\text{max}} \leq 25 \mu\text{m}$

## Installation

Please read our installation instructions.

# OS-N21

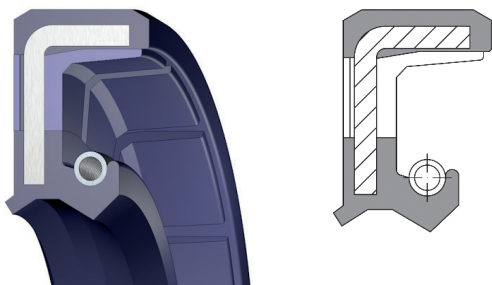

## Description

- Pressure loadable radial shaft seal
- Elastomer-coated OD, flat
- Short spring-loaded sealing lip
- Protective lip against entry of contamination from outside (dust, dirt,...)

## Special features

- Pressure loadable due to special sealing lip design
- Reliable static sealing inside housing
- For housings with high thermal expansion, e.g., light metal housing
- For split housings
- For housings with increased surface roughness
- For sealing thin-body and gaseous media
- No risk of fretting corrosion
- Efficient protection against air side contaminations

## Applications e.g.:

- Rotating / pressurized applications
- Pressurized units such as pumps or hydraulic motors

## Materials

### Standard material

Elastomer	NBR 80 blue
Spring	Spring steel according to DIN EN 10270-1
Metal case	Carbon steel according to DIN EN 10139

## Special materials

Elastomer	FKM
	Silicon
	ACM
	HNBR
	CR
	EPDM
Spring	Stainless steel 1.4301
Metal case	Stainless steel 1.4301

## Application parameters

for the standard materials combination

Temperature	-40°C to +100°C
Pressure	acc. to table „Operating parameters for rotary shaft seals“
Shaft speed	acc. to chart „Operating parameters for rotary shaft seals“
Media	Mineral oil based lubricants, synthetic lubricants

When synthetic lubricants are used for which there is no empirical experience, test the compatibility in the laboratory or - better even - in practical trials. The operating temperature should not exceed 80°C.

## Design information

### Shaft

Tolerance	ISO h11
Hardness	min. 45 HRC
Roughness	$R_a = 0.2 - 0.8 \mu\text{m}$ $R_z = 1 - 5 \mu\text{m}$ $R_{\text{max}} \leq 6.3 \mu\text{m}$
Surface finish	free of orientation (lead free)

### Housing bore

Tolerance	ISO H8
Roughness	$R_a = 1.6 - 6.3 \mu\text{m}$ $R_z = 10 - 20 \mu\text{m}$ $R_{\text{max}} \leq 25 \mu\text{m}$

## Installation

Please read our installation instructions.

# Special types

The full range of special types is available on request.  
A selection is presented below.

Section	Type	Description
	<b>OS-A12</b>	Elastomer outer diameter, sealing lip without spring (ribbed outer diameter available on request, type OS-G12)
	<b>OS-A13</b>	Elastomer outer diameter, sealing lip without spring + protective lip
	<b>OS-B13</b>	Metal outer diameter sealing lip without spring + protective lip
	<b>OS-C12</b>	Metal outer diameter +reinforcing cap, sealing lip without spring
	<b>OS-C13</b>	Metal outer diameter +reinforcing cap, sealing lip without spring
	<b>OS-G10</b>	Elastomer outer diameter, ribbed, spring loaded sealing lip
	<b>OS-G11</b>	Elastomer outer diameter, ribbed, spring loaded sealing lip + protective lip
	<b>OS-G13</b>	Elastomer outer diameter, ribbed, sealing lip without spring + protective lip

# Special types

The full range of special types is available on request.  
A selection is presented below.

Section	Type	Description
	<b>OS-N34</b>	Elastomer outer diameter, spring loaded sealing lip, pressure loadable (see operating parameters/pressure)
	<b>OS-O18</b>	Outside sealing, spring loaded sealing lip, inside diameter elastomer coated
	<b>OS-Q10</b>	Outer diameter fabric-reinforced, spring loaded sealing lip
	<b>OS-Q11</b>	Outer diameter fabric-reinforced, spring loaded sealing lip + protective lip
	<b>OS-Q12</b>	Outer diameter fabric-reinforced, spring loaded sealing lip, radial lubricating grooves on the bottom side
	<b>OS-Q13</b>	Outer diameter fabric-reinforced, spring loaded sealing lip, radial lubricating grooves on the bottom side + circumferential groove in the outer diameter
	<b>OS-BG10</b>	Outer diameter half metal, half elastomer, ribbed, spring loaded sealing lip
	<b>OS-BG11</b>	Outer diameter half metal, half elastomer, ribbed, spring loaded sealing lip + protective lip

Section	Type	Description
	<b>OS-PA30</b>	Non-mould processing, metal outer diameter, PTFE sealing lip without spring
	<b>OS-PA31</b>	Non-mould processing, metal outer diameter, PTFE sealing lip without spring
	<b>OS-PA32</b>	Non-mould processing, metal outer diameter, PTFE sealing lip without spring
	<b>OS-ST18</b>	Cassette seal
	<b>OS-W10</b>	Non-mould processing, metal outer diameter, spring loaded sealing lip
	<b>OS-W11</b>	Non-mould processing, metal outer diameter, spring loaded sealing lip + protective lip
	<b>OS-W50</b>	Non-mould processing, turned PTFE seal + O-ring on outer diameter, spring loaded sealing lip
	<b>OS-D10</b>	Elastomer outer diameter, 2 sealing lips spring-loaded, for separation of two media
	<b>OS-D15</b>	Metal outer diameter, 2 sealing lips spring-loaded, for separation of two media

where distributors go

# OS-A12

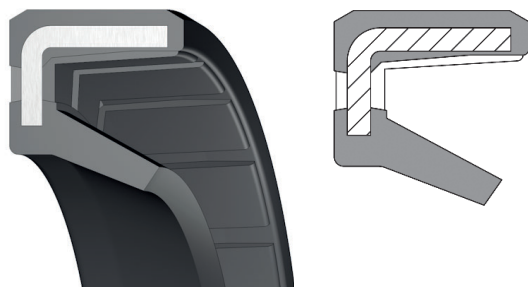

## Description

- Elastomer-coated OD, flat
- Non-spring-loaded sealing lip
- ribbed OD available on request, type G12

## Special features

- Non-spring-loaded lip design, for secondary sealing jobs e.g., grease sealing
- Low friction
- Compact design
- Little installation space
- Reliable static sealing inside housing
- For housings with high thermal expansion, e.g., light metal housing
- For split housings
- For housings with increased surface roughness
- No risk of fretting corrosion

## Applications e.g.:

- Secondary sealing jobs
- Mechanical and apparatus engineering
- Drive systems
- Electric motors

## Materials

### Standard material

Elastomer	NBR 70 black
Metal case	Carbon steel according to DIN EN 10139

## Special materials

Elastomer	FKM
	Silicon
	ACM
	HNBR
	CR
	EPDM
Metal case	Stainless steel 1.4301

## Application parameters

For the standard materials combination:

Temperature	-40°C to +100°C
Pressure	depressurized
Shaft speed	max. 6 m/s, and acc. to chart „Operating parameters for rotary shaft seals“
Media	Mineral oil based lubricants, synthetic lubricants

When synthetic lubricants are used for which there is no empirical experience, test the compatibility in the laboratory or - better even - in practical trials. The operating temperature should not exceed 80°C.

## Design information

### Shaft

Tolerance	ISO h11
Hardness	min. 45 HRC
Roughness	$R_a = 0.2 - 0.8 \mu\text{m}$ $R_z = 1 - 5 \mu\text{m}$ $R_{\text{max}} \leq 6.3 \mu\text{m}$
Surface finish	free of orientation (lead free)

### Housing bore

Tolerance	ISO H8
Roughness	$R_a = 1.6 - 6.3 \mu\text{m}$ $R_z = 10 - 20 \mu\text{m}$ $R_{\text{max}} \leq 25 \mu\text{m}$

## Installation

Please read our installation instructions.

# OS-A13

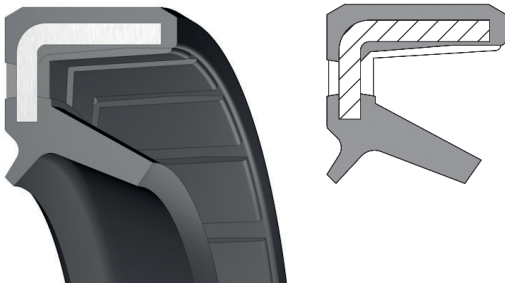

## Description

- Elastomer-coated OD, flat
  - Non-spring-loaded sealing lip
  - Protective lip against entry of contamination from outside (dust, dirt,...)
- ribbed OD available on request, type G13

## Special features

- Non-spring-loaded lip design, for secondary sealing jobs e.g., grease sealing
- Low friction
- Compact design
- Little installation space
- Reliable static sealing inside housing
- For housings with high thermal expansion, e.g., light metal housing
- For split housings
- For housings with increased surface roughness
- No risk of fretting corrosion
- Efficient protection against air side contaminations

## Applications e.g.:

Secondary sealing jobs

- Mechanical and apparatus engineering
- Drive systems
- Electric motors

## Materials

### Standard material

Elastomer	NBR 70 black
Metal case	Carbon steel according to DIN EN 10139

## Special materials

Elastomer	FKM
	Silicon
	ACM
	HNBR
	CR
	EPDM
Metal case	Stainless steel 1.4301

## Application parameters

For the standard materials combination:

Temperature	-40°C to +100°C
Pressure	depressurized
Shaft speed	max. 6 m/s, and acc. to chart „Operating parameters for rotary shaft seals“
Media	Mineral oil based lubricants, synthetic lubricants

When synthetic lubricants are used for which there is no empirical experience, test the compatibility in the laboratory or - better even - in practical trials. The operating temperature should not exceed 80°C.

## Design information

### Shaft

Tolerance	ISO h11
Hardness	min. 45 HRC
Roughness	$R_a = 0.2 - 0.8 \mu\text{m}$ $R_z = 1 - 5 \mu\text{m}$ $R_{\text{max}} \leq 6.3 \mu\text{m}$
Surface finish	free of orientation (lead free)

### Housing bore

Tolerance	ISO H8
Roughness	$R_a = 1.6 - 6.3 \mu\text{m}$ $R_z = 10 - 20 \mu\text{m}$ $R_{\text{max}} \leq 25 \mu\text{m}$

## Installation

Please read our installation instructions.

# OS-B13

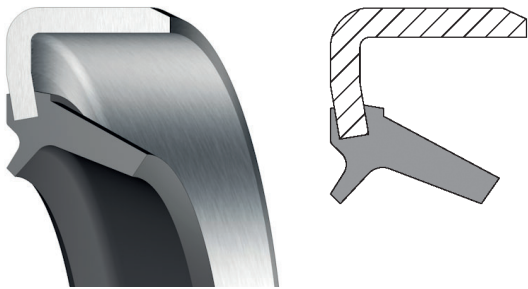

## Description

- Metal OD
- Non-spring-loaded sealing lip
- Protective lip against entry of contamination from outside (dust, dirt,...)

## Special features

- Non-spring-loaded lip design for secondary sealing jobs e.g., grease sealing
- Low friction
- Compact design
- Little installation space
- Firm and exact fit inside the housing
- Be careful when using the product in connection with light metal housings, housings with increased surface roughness and applications with overpressure: Apply sealing aid to the outside diameter if necessary. A version with outside diameter coated with bore sealant is available on request.
- Efficient protection against air side contaminations

## Applications e.g.:

Secondary sealing jobs

- Mechanical and apparatus engineering
- Drive systems
- Electric motors

## Materials

### Standard material

Elastomer	NBR 70 black
Metal case	Carbon steel according to DIN EN 10139

## Special materials

Elastomer	FKM
	Silicon
	ACM
	HNBR
	CR
	EPDM
Metal case	Stainless steel 1.4301

## Application parameters

for the standard materials combination

Temperature	-40°C to +100°C
Pressure	depressurized
Shaft speed	max. 6 m/s (and acc. to chart) „Operating parameters for rotary shaft seals“
Media	Mineral oil based lubricants, synthetic lubricants

When synthetic lubricants are used for which there is no empirical experience, test the compatibility in the laboratory or - better even - in practical trials. The operating temperature should not exceed 80°C.

## Design information

### Shaft

Tolerance	ISO h11
Hardness	min. 45 HRC
Roughness	$R_a = 0.2 - 0.8 \mu\text{m}$ $R_z = 1 - 5 \mu\text{m}$ $R_{\text{max}} \leq 6.3 \mu\text{m}$
Surface finish	free of orientation (lead free)

### Housing bore

Tolerance	ISO H8
Roughness	$R_a = 0.8 - 3,2 \mu\text{m}$ $R_z = 6.3 - 16 \mu\text{m}$ $R_{\text{max}} \leq 16 \mu\text{m}$

## Installation

Please read our installation instructions.

# OS-C12

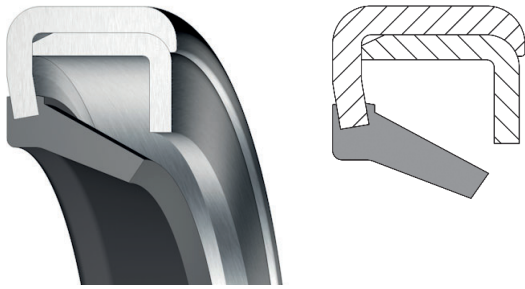

## Description

- Metal OD + reinforcement cap
- Non-spring-loaded sealing lip

## Special features

- Non-spring-loaded lip design for secondary sealing jobs e.g., grease sealing
- Low friction
- Compact design
- Little installation space
- Firm and exact fit inside the housing
- Be careful when using the product in connection with light metal housings, housings with increased surface roughness and applications with overpressure: Apply sealing aid to the outside diameter if necessary. A version with outside diameter coated with bore sealant is available on request.

## Applications e.g.:

Secondary sealing jobs

- Mechanical and apparatus engineering
- Drive systems
- Electric motors

## Materials

### Standard material

Elastomer	NBR 70 black
Metal case	Carbon steel according to DIN EN 10139

## Special materials

Elastomer	FKM
	Silicon
	ACM
	HNBR
	CR
	EPDM
Metal case	Stainless steel 1.4301

## Application parameters

for the standard materials combination

Temperature	-40°C to +100°C
Pressure	depressurized
Shaft speed	max. 6 m/s , acc. to chart „Operating parameters for rotary shaft seals“
Media	Mineral oil based lubricants, synthetic lubricants

When synthetic lubricants are used for which there is no empirical experience, test the compatibility in the laboratory or - better even - in practical trials. The operating temperature should not exceed 80°C.

## Design information

### Shaft

Tolerance	ISO h11
Hardness	min. 45 HRC
Roughness	$R_a = 0.2 - 0.8 \mu\text{m}$ $R_z = 1 - 5 \mu\text{m}$ $R_{\text{max}} \leq 6.3 \mu\text{m}$
Surface finish	free of orientation (lead free)

### Housing bore

Tolerance	ISO H8
Roughness	$R_a = 0.8 - 3,2 \mu\text{m}$ $R_z = 6.3 - 16 \mu\text{m}$ $R_{\text{max}} \leq 16 \mu\text{m}$

## Installation

Please read our installation instructions.

# OS-C13

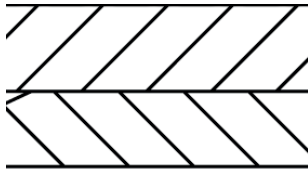

## Description

- Metal OD + reinforcement cap
- Non-spring-loaded sealing lip
- Protective lip against entry of contamination from outside (Dust, dirt,...)

## Special features

- Non-spring-loaded lip design for secondary sealing jobs e.g., grease sealing
- Low friction
- Compact design
- Little installation space
- Firm and exact fit inside the housing
- Be careful when using the product in connection with light metal housings, housings with increased surface roughness and applications with overpressure: Apply sealing aid to the outside diameter if necessary. A version with outside diameter coated with bore sealant is available on request.
- Efficient protection against air side contaminations

## Applications e.g.:

Secondary sealing jobs

- Mechanical and apparatus engineering
- Drive systems
- Electric motors

## Materials

### Standard material

Elastomer	NBR 70 black
Metal case	Carbon steel according to DIN EN 10139

## Special materials

Elastomer	FKM Silicon ACM HNBR CR EPDM
Metal case	Stainless steel 1.4301

## Application parameters

for the standard materials combination

Temperature	-40°C to +100°C
Pressure	depressurized
Shaft speed	max. 6 m/s , acc. to chart „Operating parameters for rotary shaft seals“
Media	Mineral oil based lubricants, synthetic lubricants

When synthetic lubricants are used for which there is no empirical experience, test the compatibility in the laboratory or - better even - in practical trials. The operating temperature should not exceed 80°C.

## Design information

### Shaft

Tolerance	ISO h11
Hardness	min. 45 HRC
Roughness	$R_a = 0.2 - 0.8 \mu\text{m}$ $R_z = 1 - 5 \mu\text{m}$ $R_{\text{max}} \leq 6.3 \mu\text{m}$
Surface finish	free of orientation (lead free)

### Housing bore

Tolerance	ISO H8
Roughness	$R_a = 0.8 - 3,2 \mu\text{m}$ $R_z = 6.3 - 16 \mu\text{m}$ $R_{\text{max}} \leq 16 \mu\text{m}$

## Installation

Please read our installation instructions.

# OS-G10

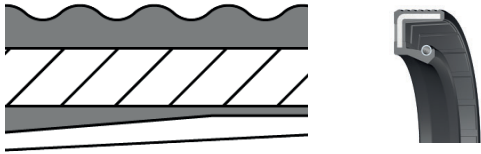

## Description

- Elastomer-coated OD, ribbed
- Spring-loaded sealing lip

## Special features

- Modern sealing lip design for high dynamic sealing action
- Reliable static sealing inside housing
- For housings with high thermal expansion, e.g., light metal housing
- For split housings
- For housings with increased surface roughness  
For sealing thin-body and gaseous media
- No risk of fretting corrosion

## Applications e.g.:

- Mechanical and apparatus engineering
- Agricultural machinery
- Construction machines
- Drive systems, industrial gearboxes, electric motors

## Materials

### Standard material

Elastomer	NBR 70 black
Spring	Spring steel according to DIN EN 10270-1
Metal case	Carbon steel according to DIN EN 10139

## Special materials

Elastomer	FKM Silicone ACM HNBR CR EPDM
Spring	Stainless steel 1.4301
Metal case	Stainless steel 1.4301

## Application parameters

for the standard materials combination

Temperature	-40°C to +100°C
Pressure	depressurized, max. 0.05 MPa
Shaft speed	acc. to chart „Operating parameters for rotary shaft seals“
Media	Mineral oil based lubricants, synthetic lubricants

When synthetic lubricants are used for which there is no empirical experience, test the compatibility in the laboratory or - better even - in practical trials. The operating temperature should not exceed 80°C.

## Design information

### Shaft

Tolerance	ISO h11
Hardness	min. 45 HRC
Roughness	$R_a = 0.2 - 0.8 \mu\text{m}$ $R_z = 1 - 5 \mu\text{m}$ $R_{\text{max}} \leq 6.3 \mu\text{m}$
Surface finish	free of orientation (lead free)

### Housing bore

Tolerance	ISO H8
Roughness	$R_a = 1.6 - 6.3 \mu\text{m}$ $R_z = 10 - 20 \mu\text{m}$ $R_{\text{max}} \leq 25 \mu\text{m}$

## Installation

Please read our installation instructions.

# OS-G11

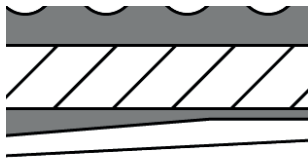

## Description

- Elastomer-coated OD, ribbed
- Non-spring-loaded sealing lip
- Protective lip against entry of contamination from outside (dust, dirt,...)

## Special features

- Modern sealing lip design for high dynamic sealing action
- Reliable static sealing inside housing
- For housings with high thermal expansion, e.g., light metal housing
- For split housings
- For housings with increased surface roughness
- For sealing thin-body and gaseous media
- No risk of fretting corrosion
- Efficient protection against air side contaminations

## Applications e.g.:

- Mechanical and apparatus engineering
- Agricultural machinery
- Construction machines
- Drive systems, industrial gearboxes, electric motors

## Materials

### Standard material

Elastomer	NBR 70 black
Spring	Spring steel according to DIN EN 10270-1
Metal case	Carbon steel according to DIN EN 10139

## Special materials

Elastomer	FKM Silicone ACM HNBR CR EPDM
Spring	Stainless steel 1.4301
Metal case	Stainless steel 1.4301

## Application parameters

for the standard materials combination

Temperature	-40°C to +100°C
Pressure	depressurized, max. 0.05 MPa
Shaft speed	acc. to chart „Operating parameters for rotary shaft seals“
Media	Mineral oil based lubricants, synthetic lubricants

When synthetic lubricants are used for which there is no empirical experience, test the compatibility in the laboratory or - better even - in practical trials. The operating temperature should not exceed 80°C.

## Design information

### Shaft

Tolerance	ISO h11
Hardness	min. 45 HRC
Roughness	$R_a = 0.2 - 0.8 \mu\text{m}$ $R_z = 1 - 5 \mu\text{m}$ $R_{\text{max}} \leq 6.3 \mu\text{m}$
Surface finish	free of orientation (lead free)

### Housing bore

Tolerance	ISO H8
Roughness	$R_a = 1.6 - 6.3 \mu\text{m}$ $R_z = 10 - 20 \mu\text{m}$ $R_{\text{max}} \leq 25 \mu\text{m}$

## Installation

Please read our installation instructions.

# OS-G13

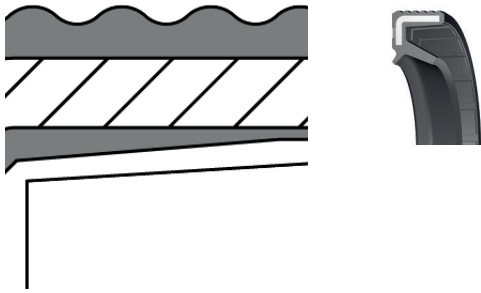

## Description

- Elastomer-coated OD, ribbed
- Non-spring-loaded sealing lip
- Protective lip against entry of contamination from outside (dust, dirt,...)

## Special features

- Non-spring-loaded lip design, for secondary sealing jobs e.g., grease sealing
- Low friction
- Compact design
- Little installation space
- Reliable static sealing inside housing
- For housings with high thermal expansion, e.g., light metal housing
- For split housings
- For housings with increased surface roughness
- No risk of fretting corrosion
- Efficient protection against air side contaminations

## Applications e.g.:

- Secondary sealing jobs
- Mechanical and apparatus engineering
- Drive systems
- Electric motors

## Materials

### Standard material

Elastomer	NBR 70 green
Metal case	Carbon steel according to DIN EN 10139

## Special materials

Elastomer	FKM Silicon ACM HNBR CR EPDM
Metal case	Stainless steel 1.4301

## Application parameters

For the standard materials combination:

Temperature	-40°C to +100°C
Pressure	depressurized
Shaft speed	max. 6 m/s, and acc. to chart „Operating parameters for rotary shaft seals“
Media	Mineral oil based lubricants, synthetic lubricants

When synthetic lubricants are used for which there is no empirical experience, test the compatibility in the laboratory or - better even - in practical trials. The operating temperature should not exceed 80°C.

## Design information

### Shaft

Tolerance	ISO h11
Hardness	min. 45 HRC
Roughness	$R_a = 0.2 - 0.8 \mu\text{m}$ $R_z = 1 - 5 \mu\text{m}$ $R_{\text{max}} \leq 6.3 \mu\text{m}$
Surface finish	free of orientation (lead free)

### Housing bore

Tolerance	ISO H8
Roughness	$R_a = 1.6 - 6.3 \mu\text{m}$ $R_z = 10 - 20 \mu\text{m}$ $R_{\text{max}} \leq 25 \mu\text{m}$

## Installation

Please read our installation instructions.

# OS-N34

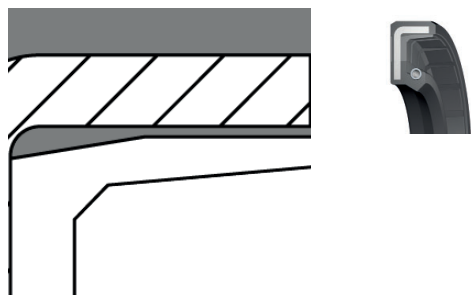

## Description

- Pressure loadable radial shaft seal
- Elastomer-coated OD, flat
- Short spring-loaded sealing lip

## Special features

- Pressure loadable due to special sealing lip design
- Reliable static sealing inside housing
- For housings with high thermal expansion, e.g., light metal housing
- For split housings
- For housings with increased surface roughness
- For sealing thin-body and gaseous media
- No risk of fretting corrosion

## Applications e.g.:

- Rotating / pressurized applications
- Pressurized units such as pumps or hydraulic motors

## Materials

### Standard material

Elastomer	NBR 80 blue
Spring	Spring steel according to DIN EN 10270-1
Metal case	Carbon steel according to DIN EN 10139

## Special materials

Elastomer	FKM
	Silicon
	ACM
	HNBR
	CR
	EPDM
Spring	Stainless steel 1.4301
Metal case	Stainless steel 1.4301

## Application parameters

for the standard materials combination

Temperature	-40°C to +100°C
Pressure	acc. to table „Operating parameters for rotary shaft seals“
Shaft speed	acc. to chart „Operating parameters for rotary shaft seals“
Media	Mineral oil based lubricants, synthetic lubricants

When synthetic lubricants are used for which there is no empirical experience, test the compatibility in the laboratory or - better even - in practical trials. The operating temperature should not exceed 80°C.

## Design information

### Shaft

Tolerance	ISO h11
Hardness	min. 45 HRC
Roughness	$R_a = 0.2 - 0.8 \mu\text{m}$ $R_z = 1 - 5 \mu\text{m}$ $R_{\text{max}} \leq 6.3 \mu\text{m}$
Surface finish	free of orientation (lead free)

### Housing bore

Tolerance	ISO H8
Roughness	$R_a = 1.6 - 6.3 \mu\text{m}$ $R_z = 10 - 20 \mu\text{m}$ $R_{\text{max}} \leq 25 \mu\text{m}$

## Installation

Please read our installation instructions.

# OS-018

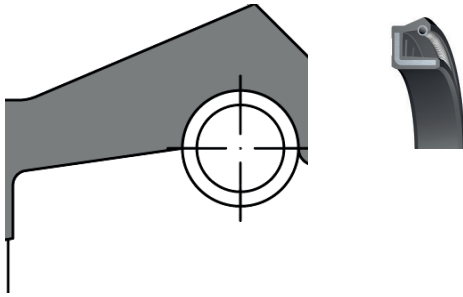

## Description

- Outside sealing,
- spring loaded sealing lip,
- inside diameter elastomer coated

## Special features

- Modern sealing lip design for high dynamic sealing action
- Reliable static sealing inside housing
- For housings with high thermal expansion,
- e.g., light metal housing
- For split housings
- For housings with increased surface roughness For sealing thin-body and gaseous media
- No risk of fretting corrosion

## Applications e.g.:

- Mechanical and apparatus engineering
- Agricultural machinery
- Construction machines
- Drive systems, industrial gearboxes, electric motors

## Materials

### Standard material

Elastomer	NBR 70 black
Spring	Spring steel according to DIN EN 10270-1
Metal case	Carbon steel according to DIN EN 10139

## Special materials

Elastomer	FKM
	Silicon
	ACM
	HNBR
	CR
	EPDM
Spring	Stainless steel 1.4301
Metal case	Stainless steel 1.4301

## Application parameters

For the standard materials combination:

Temperature	-40°C to +100°C
Pressure	depressurized, max. 0.05 MPa
Shaft speed	acc. to chart „Operating parameters for rotary shaft seals“
Media	Mineral oil based lubricants, synthetic lubricants

When synthetic lubricants are used for which there is no empirical experience, test the compatibility in the laboratory or - better even - in practical trials. The operating temperature should not exceed 80°C.

## Design information

### Shaft

Tolerance	ISO h11
Hardness	min. 45 HRC
Roughness	$R_a = 0.2 - 0.8 \mu\text{m}$ $R_z = 1 - 5 \mu\text{m}$ $R_{\text{max}} \leq 6.3 \mu\text{m}$
Surface finish	free of orientation (lead free)

### Housing bore

Tolerance	ISO H8
Roughness	$R_a = 1.6 - 6.3 \mu\text{m}$ $R_z = 10 - 20 \mu\text{m}$ $R_{\text{max}} \leq 25 \mu\text{m}$

## Installation

Please read our installation instructions.

# OS-Q10

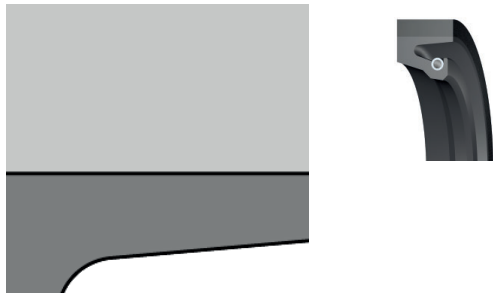

## Description

- Fabric-reinforced OD
- Spring-loaded elastomer sealing lip

## Special features

- Modern sealing lip design for high dynamic sealing action
- Robust, fabric-reinforced outer diameter (no metal case)
- High resistance to wear
- For housings with increased surface roughness
- Simple installation and replacement of the seal possible
- All components of the seal are corrosion-resistant
- Split design available, can be replaced without deinstallation of the shaft

## Applications e.g.:

- Heavy machinery
- Marine applications
- Rolling mills
- Wind power systems
- Large gearboxes

## Materials

### Standard material

Sealing lip	NBR 80
OD layer	NBR-impregnated cotton fabric
Spring	Stainless steel 1.4310

## Special materials

Sealing lip	FKM 80
OD layer	FKM-impregnated cotton fabric
Spring	Stainless steel 1.4310

## Application parameters

for the standard materials combination

Temperature	-30°C to +100°C
Pressure	max. 0.05 MPa
Shaft speed	max. 20 m/s
Media	Mineral oil based lubricants

The different permitted maximum values should always be seen in connection with all application parameters. The total load on the seal is the combination of individual values.

## Design information

### Shaft

Tolerance	ISO h9
Hardness	60 HRC
Roughness	$R_a = 0.2 - 0.8 \mu\text{m}$ $R_{\text{max}} \leq 2,5 \mu\text{m}$
Surface finish	free of orientation (lead free)

### Housing bore

Tolerance	$D \leq 500\text{mm}$ : ISO H8 $D > 500\text{mm}$ : $D+0.0004 \times D$
Roughness	$R_a = 1.6 - 4 \mu\text{m}$ $R_{\text{max}} \leq 15 \mu\text{m}$

## Installation

The radial shaft seal is installed in an axially accessible housing. The outer diameter and the height of the seal are slightly oversized. The outer diameter is somewhat compressed during installation. Tightening the flange cover also causes slight axial compression of the seal height. The types OS-Q12 and OS-Q13 are installed in pairs back to back, as a rule.

Please read our installation instructions.

# OS-Q11

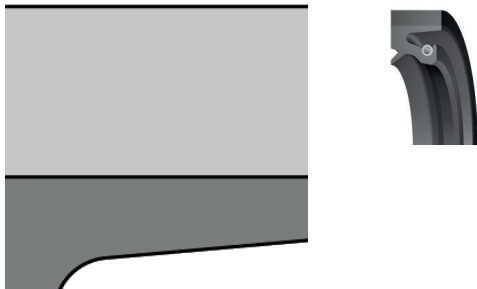

## Description

- Fabric-reinforced OD
- Spring-loaded elastomer sealing lip
- Protective lip against entry of contamination from outside (dust, dirt,...)

## Special features

- Modern sealing lip design for high dynamic sealing action
- Robust, fabric-reinforced outer diameter (no metal case)
- High resistance to wear
- For housings with increased surface roughness
- Simple installation and replacement of the seal possible
- All components of the seal are corrosion-resistant
- Split design available, can be replaced without deinstallation of the shaft
- Efficient protection against air side contaminations

## Applications e.g.:

- Heavy machinery
- Marine applications
- Rolling mills
- Wind power systems
- Large gearboxes

## Materials

### Standard material

Sealing lip	NBR 80
OD layer	NBR-impregnated cotton fabric
Spring	Stainless steel 1.4310

## Special materials

Sealing lip	FKM 80
OD layer	FKM-impregnated cotton fabric
Spring	Stainless steel 1.4310

## Application parameters

for the standard materials combination

Temperature	-30°C to +100°C
Pressure	max. 0.05 MPa
Shaft speed	max. 20 m/s
Media	Mineral oil based lubricants

The different permitted maximum values should always be seen in connection with all application parameters. The total load on the seal is the combination of individual values.

## Design information

### Shaft

Tolerance	ISO h9
Hardness	60 HRC
Roughness	$R_a = 0.2 - 0.8 \mu\text{m}$ $R_{\text{max}} \leq 2,5 \mu\text{m}$
Surface finish	free of orientation (lead free)

### Housing bore

Tolerance	$D \leq 500\text{mm}$ : ISO H8 $D > 500\text{mm}$ : $D+0.0004 \times D$
Roughness	$R_a = 1.6 - 4 \mu\text{m}$ $R_{\text{max}} \leq 15 \mu\text{m}$

## Installation

The radial shaft seal is installed in an axially accessible housing. The outer diameter and the height of the seal are slightly oversized. The outer diameter is somewhat compressed during installation. Tightening the flange cover also causes slight axial compression of the seal height. The types OS-Q12 and OS-Q13 are installed in pairs back to back, as a rule.

Please read our installation instructions.

# OS-Q12

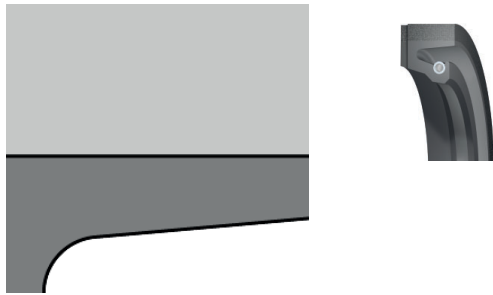

## Description

- Fabric-reinforced OD
- Spring-loaded elastomer sealing lip
- Radial lubricating grooves at the bottom side
- Relubrication is possible if 2 seals are installed back-to-back;  
For this the housing is provided with a circumferential annular groove and lubrication connection

## Special features

- Modern sealing lip design for high dynamic sealing action
- Robust, fabric-reinforced outer diameter (no metal case)
- High resistance to wear
- For housings with increased surface roughness
- Simple installation and replacement of the seal possible
- All components of the seal are corrosion-resistant
- Split design available, can be replaced without deinstallation of the shaft
- Relubrication possible by radial grooves

## Applications e.g.:

- Heavy machinery
- Marine applications
- Rolling mills
- Wind power systems
- Large gearboxes

## Materials

### Standard material

Sealing lip	NBR 80
OD layer	NBR-impregnated cotton fabric
Spring	Stainless steel 1.4310

## Special materials

Sealing lip	FKM 80
OD layer	FKM- impregnated cotton fabric
Spring	Stainless steel 1.4310

## Application parameters

for the standard materials combination

Temperature	-30°C to +100°C
Pressure	max. 0.05 MPa
Shaft speed	max. 20 m/s
Media	Mineral oil based lubricants

The different permitted maximum values should always be seen in connection with all application parameters. The total load on the seal is the combination of individual values.

## Design information

### Shaft

Tolerance	ISO h9
Hardness	60 HRC
Roughness	$R_a = 0.2 - 0.8 \mu\text{m}$ $R_{\text{max}} \leq 2,5 \mu\text{m}$
Surface finish	free of orientation (lead free)

### Housing bore

Tolerance	$D \leq 500\text{mm}$ : ISO H8 $D > 500\text{mm}$ : $D+0.0004 \times D$
Roughness	$R_a = 1.6 - 4 \mu\text{m}$ $R_{\text{max}} \leq 15 \mu\text{m}$

## Installation

The radial shaft seal is installed in an axially accessible housing. The outer diameter and the height of the seal are slightly oversized. The outer diameter is somewhat compressed during installation. Tightening the flange cover also causes slight axial compression of the seal height. The types OS-Q12 and OS-Q13 are installed in pairs back to back, as a rule.

Please read our installation instructions.

# OS-Q13

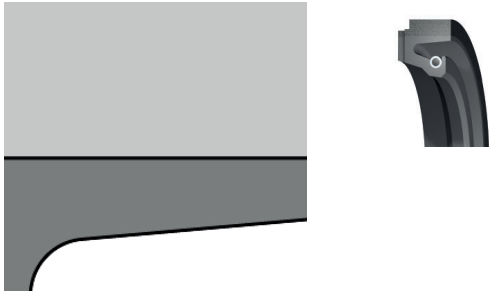

## Description

- Fabric-reinforced OD
- Spring-loaded elastomer sealing lip
- Radial and annular lubricating grooves at the bottom side
- Relubrication is possible if 2 seals are installed back-to-back

## Special features

- Modern sealing lip design for high dynamic sealing action
- Robust, fabric-reinforced outer diameter (no metal case)
- High resistance to wear
- For housings with increased surface roughness
- Simple installation and replacement of the seal possible
- All components of the seal are corrosion-resistant
- Split design available, can be replaced without deinstallation of the shaft
- Relubrication possible due to radial and annular grooves

## Applications e.g.:

- Heavy machinery
- Marine applications
- Rolling mills
- Wind power systems
- Large gearboxes

## Materials

### Standard material

Sealing lip	NBR 80
OD layer	NBR-impregnated cotton fabric
Spring	Stainless steel 1.4310

## Special materials

Sealing lip	FKM 80
OD layer	FKM- impregnated cotton fabric
Spring	Stainless steel 1.4310

## Application parameters

for the standard materials combination

Temperature	-30°C to +100°C
Pressure	max. 0.05 MPa
Shaft speed	max. 20 m/s
Media	Mineral oil based lubricants

The different permitted maximum values should always be seen in connection with all application parameters. The total load on the seal is the combination of individual values.

## Design information

### Shaft

Tolerance	ISO h9
Hardness	60 HRC
Roughness	$R_a = 0.2 - 0.8 \mu\text{m}$ $R_{\text{max}} \leq 2,5 \mu\text{m}$
Surface finish	free of orientation (lead free)

### Housing bore

Tolerance	$D \leq 500\text{mm}$ : ISO H8 $D > 500\text{mm}$ : $D+0.0004 \times D$
Roughness	$R_a = 1.6 - 4 \mu\text{m}$ $R_{\text{max}} \leq 15 \mu\text{m}$

## Installation

The radial shaft seal is installed in an axially accessible housing. The outer diameter and the height of the seal are slightly oversized. The outer diameter is somewhat compressed during installation. Tightening the flange cover also causes slight axial compression of the seal height. The types OS-Q12 and OS-Q13 are installed in pairs back to back, as a rule.

Please read our installation instructions.

# OS-BG10

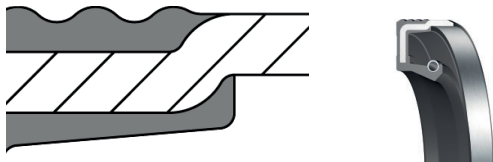

## Description

- Metal and rubber OD, ribbed
- Spring loaded sealing lip

## Special features

- Combines the advantages of metal and elastomer OD:
- Very firm and exact fit inside the housing due to metal-metal interference fit
- Reliable static sealing inside housing
- Compensation of different thermal expansion
- Modern sealing lip design for high dynamic sealing action

## Applications e.g.:

- Mechanical engineering
- Machine tools
- Drive systems

## Materials

### Standard material

Elastomer	NBR 70 black
Spring	Spring steel according to DIN EN 10270-1
Metal case	Carbon steel according to DIN EN 10139

## Special materials

Elastomer	FKM
	Silicon
	ACM
	HNBR
	CR
	EPDM
Spring	Stainless steel 1.4301
Metal case	Stainless steel 1.4301

## Application parameters

for the standard materials combination

Temperature	-40°C to +100°C
Pressure	depressurized, max. 0.05 MPa
Shaft speed	acc. to chart in „Operating parameters for rotary shaft seals“
Media	Mineral oil based lubricants, synthetic lubricants

When synthetic lubricants are used for which there is no empirical experience, test the compatibility in the laboratory or - better even - in practical trials. The operating temperature should not exceed 80°C.

## Design information

### Shaft

Tolerance	ISO h11
Hardness	min. 45 HRC
Roughness	$R_a = 0.2 - 0.8 \mu\text{m}$ $R_z = 1 - 5 \mu\text{m}$ $R_{\text{max}} \leq 6.3 \mu\text{m}$
Surface finish	free of orientation (lead free)

### Housing bore

Tolerance	ISO H8
Roughness	$R_a = 1.6 - 6.3 \mu\text{m}$ $R_z = 10 - 20 \mu\text{m}$ $R_{\text{max}} \leq 25 \mu\text{m}$

## Installation

Please read our installation instructions.

# OS-BG11

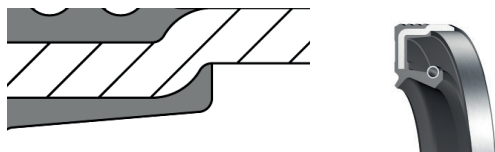

## Description

- Metal and rubber OD, ribbed
- Spring loaded sealing lip
- Protective lip against entry of contamination from outside (dust, dirt,...)

## Special features

- Combines the advantages of metal and elastomer OD:
- Very firm and exact fit inside the housing due to metal-metal interference fit
- Reliable static sealing inside housing
- Compensation of different thermal expansion
- Modern sealing lip design for high dynamic sealing action
- Efficient protection against air side contaminations

## Applications e.g.:

- Mechanical engineering
- Machine tools
- Drive systems

## Materials

### Standard material

Elastomer	NBR 70 black
Spring	Spring steel according to DIN EN 10270-1
Metal case	Carbon steel according to DIN EN 10139

## Special materials

Elastomer	FKM Silicon ACM HNBR CR EPDM
Spring	Stainless steel 1.4301
Metal case	Stainless steel 1.4301

## Application parameters

for the standard materials combination

Temperature	-40°C to +100°C
Pressure	depressurized, max. 0.05 MPa
Shaft speed	acc. to chart in „Operating parameters for rotary shaft seals“
Media	Mineral oil based lubricants, synthetic lubricants

When synthetic lubricants are used for which there is no empirical experience, test the compatibility in the laboratory or - better even - in practical trials. The operating temperature should not exceed 80°C.

## Design information

### Shaft

Tolerance	ISO h11
Hardness	min. 45 HRC
Roughness	$R_a = 0.2 - 0.8 \mu\text{m}$ $R_z = 1 - 5 \mu\text{m}$ $R_{\text{max}} \leq 6.3 \mu\text{m}$
Surface finish	free of orientation (lead free)

### Housing bore

Tolerance	ISO H8
Roughness	$R_a = 1.6 - 6.3 \mu\text{m}$ $R_z = 10 - 20 \mu\text{m}$ $R_{\text{max}} \leq 25 \mu\text{m}$

## Installation

Please read our installation instructions.

# OS-PA30

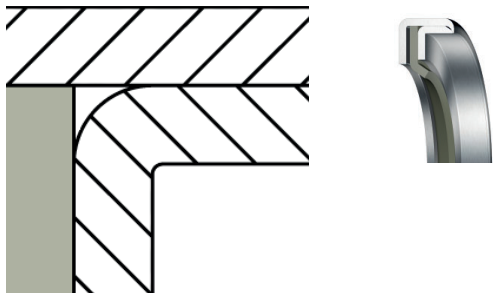

## Description

- Pressure loadable radial shaft seal
- Metal OD
- Sealing lip made of PTFE
- Sealing lip with elastomer washer, clamped between 2 metal cases

## Special features

- Permits high shaft speeds
- High thermal resistance
- High chemical resistance
- Pressure loadable
- Applicable with insufficient lubrication and dry running
- Very low friction coefficient, stick-slip free running
- Non-moulded processing
- Inside diameter from 20mm possible
- Small runs without mould cost possible
- Short delivery time
- Very firm and exact fit inside the housing due to metal-metal interference fit
- Be careful when using the product in connection with light metal housings, housings with increased surface roughness and applications with overpressure: Apply sealing aid to the outside diameter if necessary.

## Applications e.g.:

- Chemical industry
- Mechanical and apparatus engineering
- Drive systems

## Materials

### Standard material

Sealing lip	PTFE / glass fibre / MoS2
Metal case	Stainless steel 1.4404 (AISI316L)
Elastomer washer	FKM

### Special materials

Sealing lip	PTFE / carbon graphite
Metal case	Standard steel
Elastomer washer	Other elastomers on request

## Application parameters

for the standard materials combination

Temperature	-90°C to +250°C
Pressure	max. 0.5 MPa
Shaft speed	max. 40 m/s
Media	Mineral oil based lubricants, synthetic lubricants, many acids and lyes, solvents, water

The different permitted maximum values should always be seen in connection with all application parameters. The total load on the seal is the combination of individual values.

## Design information

### Shaft

Tolerance	ISO h11
Hardness	min. 50 HRC
Roughness	$R_a = 0.2 - 0.8 \mu\text{m}$ $R_z = 1 - 5 \mu\text{m}$ $R_{\text{max}} \leq 6.3 \mu\text{m}$
Surface finish	free of orientation (lead free)

### Housing bore

Tolerance	ISO H8
Roughness	$R_a = 0.8 - 3,2 \mu\text{m}$ $R_z = 6.3 - 16 \mu\text{m}$ $R_{\text{max}} \leq 16 \mu\text{m}$

## Installation

Please read our installation instructions.

# OS-PA31

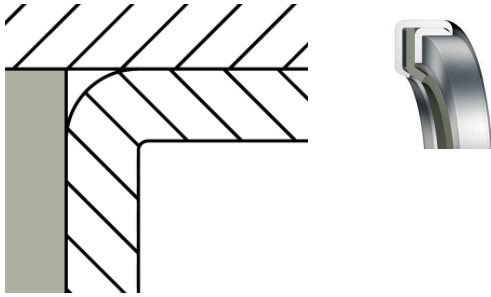

## Description

- Pressure loadable radial shaft seal
- Metal OD
- Sealing lip made of PTFE
- Sealing lip with elastomer washer, clamped between 2 metal cases

## Special features

- Permits high shaft speeds
- High thermal resistance
- High chemical resistance
- Pressure loadable
- Applicable with insufficient lubrication and dry running
- Very low friction coefficient, stick-slip free running
- Non-moulded processing
- Inside diameter from 31mm possible
- Small runs without mould cost possible
- Short delivery time
- Very firm and exact fit inside the housing due to metal-metal interference fit
- Be careful when using the product in connection with light metal housings, housings with increased surface roughness and applications with overpressure: Apply sealing aid to the outside diameter if necessary.

## Applications e.g.:

- Chemical industry
- Mechanical and apparatus engineering
- Drive systems

## Materials

### Standard material

Sealing lip	PTFE / glass fibre / MoS <sub>2</sub>
Metal case	Stainless steel 1.4404 (AISI316L)
Elastomer washer	FKM

### Special materials

Sealing lip	PTFE / carbon graphite
Metal case	Standard steel
Elastomer washer	Other elastomers on request

## Application parameters

for the standard materials combination

Temperature	-90°C to +250°C
Pressure	max. 1 MPa
Shaft speed	max. 40 m/s
Media	Mineral oil based lubricants, synthetic lubricants, many acids and lyes, solvents, water

The different permitted maximum values should always be seen in connection with all application parameters. The total load on the seal is the combination of individual values.

## Design information

### Shaft

Tolerance	ISO h11
Hardness	min. 50 HRC
Roughness	$R_a = 0.2 - 0.8 \mu\text{m}$ $R_z = 1 - 5 \mu\text{m}$ $R_{\text{max}} \leq 6.3 \mu\text{m}$
Surface finish	free of orientation (lead free)

### Housing bore

Tolerance	ISO H8
Roughness	$R_a = 0.8 - 3,2 \mu\text{m}$ $R_z = 6.3 - 16 \mu\text{m}$ $R_{\text{max}} \leq 16 \mu\text{m}$

## Installation

Please read our installation instructions.

# OS-PA32

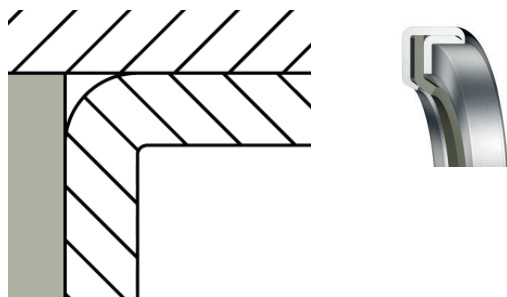

## Description

- Pressure loadable radial shaft seal
- Metal OD
- Sealing lip made of PTFE
- Sealing lip with elastomer washer, clamped between 2 metal cases

## Special features

- Permits high shaft speeds
- High thermal resistance
- High chemical resistance
- Pressure loadable
- Applicable with insufficient lubrication and dry running
- Very low friction coefficient, stick-slip free running
- Non-moulded processing
- Inside diameter from 31mm possible
- Small runs without mould cost possible
- Short delivery time
- Very firm and exact fit inside the housing due to metal-metal interference fit
- Be careful when using the product in connection with light metal housings, housings with increased surface roughness and applications with overpressure: Apply sealing aid to the outside diameter if necessary.

## Applications e.g.:

- Chemical industry
- Mechanical and apparatus engineering
- Drive systems

## Materials

### Standard material

Sealing lip	PTFE / glass fibre / MoS2
Metal case	Stainless steel 1.4404 (AISI316L)
Elastomer washer	FKM

### Special materials

Sealing lip	PTFE / carbon graphite
Metal case	Standard steel
Elastomer washer	Other elastomers on request

## Application parameters

for the standard materials combination

Temperature	-90°C to +250°C
Pressure	max. 2.5 MPa
Shaft speed	max. 40 m/s
Media	Mineral oil based lubricants, synthetic lubricants, many acids and lyes, solvents, water

The different permitted maximum values should always be seen in connection with all application parameters. The total load on the seal is the combination of individual values.

## Design information

### Shaft

Tolerance	ISO h11
Hardness	min. 50 HRC
Roughness	$R_a = 0.2 - 0.8 \mu\text{m}$ $R_z = 1 - 5 \mu\text{m}$ $R_{\text{max}} \leq 6.3 \mu\text{m}$
Surface finish	free of orientation (lead free)

### Housing bore

Tolerance	ISO H8
Roughness	$R_a = 0.8 - 3,2 \mu\text{m}$ $R_z = 6.3 - 16 \mu\text{m}$ $R_{\text{max}} \leq 16 \mu\text{m}$

## Installation

Please read our installation instructions.

# OS-W10

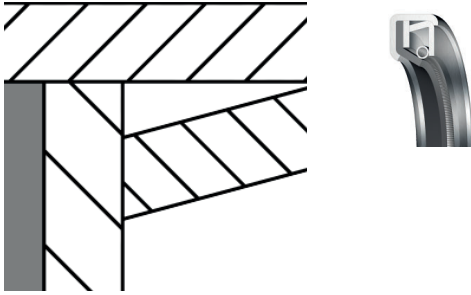

## Description

- Pressure loadable radial shaft seal
- Metal OD
- Spring-loaded elastomer sealing lip
- Sealing lip is clamped between the metal cases

## Special features

- Pressure loadable
- Non-moulded processing
- Inside diameter from 45mm / outside diameter from 65mm to 1220mm possible
- No extra cost for special sizes or special tolerances
- Small runs without mould cost possible
- Short delivery time
- Very firm and exact fit inside the housing due to metal-metal interference fit
- Be careful when using the product in connection with light housings, housings with increased surface roughness and applications with overpressure: Apply sealing aid to the outside diameter if necessary

## Applications e.g.:

- Heavy engineering
- General mechanical engineering

## Materials

### Standard material

Sealing lip	NBR
Metal case	Carbon steel
Spring	Carbon spring steel

## Special materials

Sealing lip	FKM, Silicon, EPDM
Metal case	Stainless steel AISI 316L
Spring	Stainless steel AISI 316L

## Application parameters

for the standard materials combination

Temperature	-40°C to +100°C
Pressure	max. 0.5 MPa (optional 1 MPa)
Shaft speed	max. 12 m/s
Media	Mineral oil based lubricants, synthetic lubricants

When synthetic lubricants are used for which there is no empirical experience, test the compatibility in the laboratory or - better even - in practical trials.

The operating temperature should not exceed 80°C.

The different permitted maximum values should always be seen in connection with all application parameters. The total load on the seal is the combination of individual values.

## Design information

### Shaft

Tolerance	ISO h11
Hardness	min. 45 HRC
Roughness	$R_a = 0.2 - 0.8 \mu\text{m}$ $R_z = 1 - 5 \mu\text{m}$ $R_{\text{max}} \leq 6.3 \mu\text{m}$
Surface finish	free of orientation (lead free)

### Housing bore

Tolerance	ISO H8
Roughness	$R_a = 0.8 - 3,2 \mu\text{m}$ $R_z = 6.3 - 16 \mu\text{m}$ $R_{\text{max}} \leq 16 \mu\text{m}$

## Installation

Please read our installation instructions.

# OS-W11

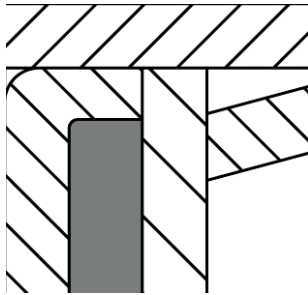

## Description

- Pressure loadable radial shaft seal
- Metal OD
- Spring-loaded elastomer sealing lip
- Protective lip against entry of contamination from outside (dust, dirt,...)
- Sealing lip and protective lip are clamped between the metal cases

## Special features

- Pressure loadable
- Non-moulded processing
- Inside diameter from 45mm / outside diameter from 65mm to 1220mm possible
- No extra cost for special sizes or special tolerances
- Small runs without mould cost possible
- Short delivery time
- Very firm and exact fit inside the housing due to metal-metal interference fit
- Be careful when using the product in connection with light metal housings, housings with increased surface roughness and applications with overpressure: Apply sealing aid to the outside diameter if necessary.
- Efficient protection against air side contaminations

## Applications e.g.:

- Heavy engineering
- General mechanical engineering

## Materials

### Standard material

Sealing lip	NBR
Metal case	Carbon steel
Spring	Carbon spring steel

## Special materials

Sealing lip	FKM, Silicon, EPDM
Metal case	Stainless steel AISI 316L
Spring	Stainless steel AISI 316L

## Application parameters

for the standard materials combination

Temperature	-40°C to +100°C
Pressure	max. 0.5 MPa (optional 1 MPa)
Shaft speed	max. 8 m/s
Media	Mineral oil based lubricants, synthetic lubricants

When synthetic lubricants are used for which there is no empirical experience, test the compatibility in the laboratory or - better even - in practical trials.

The operating temperature should not exceed 80°C.

The different permitted maximum values should always be seen in connection with all application parameters.

The total load on the seal is the combination of individual values.

## Design information

### Shaft

Tolerance	ISO h11
Hardness	min. 45 HRC
Roughness	$R_a = 0.2 - 0.8 \mu\text{m}$ $R_z = 1 - 5 \mu\text{m}$ $R_{\text{max}} \leq 6.3 \mu\text{m}$
Surface finish	free of orientation (lead free)

### Housing bore

Tolerance	ISO H8
Roughness	$R_a = 0.8 - 3.2 \mu\text{m}$ $R_z = 6.3 - 16 \mu\text{m}$ $R_{\text{max}} \leq 16 \mu\text{m}$

## Installation

Please read our installation instructions.

# OS-D10



## Description

- Double-acting radial shaft seal
- Two spring-loaded sealing lips
- Elastomer-coated OD, flat ribbed OD available on request, type OS-D11

## Special features

- Separation of two media by just one seal
- Combination of 2 sealing lips in one component
- Reliable static sealing inside housing
- For housings with high thermal expansion, e.g., light metal housing
- For split housings
- For housings with increased surface roughness
- No risk of fretting corrosion

## Applications e.g.:

- Separation of two media with rotating machine parts

## Materials

### Standard material

Elastomer	NBR 70 black
Spring	Spring steel according to DIN EN 10270-1
Metal case	Carbon steel according to DIN EN 10139

## Special materials

Elastomer	FKM
	Silicon
	ACM
	HNBR
	CR
	EPDM
Springs	Stainless steel 1.4301
Metal case	Stainless steel 1.4301

## Application parameters

for the standard materials combination

Temperature	-40°C to +100°C
Pressure	depressurized, max. 0.02 MPa
Shaft speed	max. 5 m/s , acc. to chart „Operating parameters for rotary shaft seals“
Media	Mineral oil based lubricants, synthetic lubricants

When synthetic lubricants are used for which there is no empirical experience, test the compatibility in the laboratory or - better even - in practical trials. The operating temperature should not exceed 80°C.

## Design information

### Shaft

Tolerance	ISO h11
Hardness	min. 45 HRC
Roughness	$R_a = 0.2 - 0.8 \mu\text{m}$ $R_z = 1 - 5 \mu\text{m}$ $R_{\text{max}} \leq 6.3 \mu\text{m}$
Surface finish	free of orientation (lead free)

### Housing bore

Tolerance	ISO H8
Roughness	$R_a = 1.6 - 6.3 \mu\text{m}$ $R_z = 10 - 20 \mu\text{m}$ $R_{\text{max}} \leq 25 \mu\text{m}$

## Installation

Please read our installation instructions.

# OS-D15

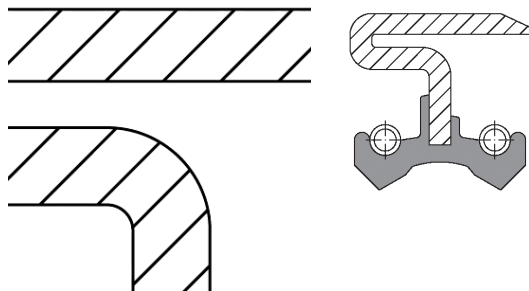

## Description

- Double-acting radial shaft seal
- Two spring-loaded sealing lips
- Metal OD

## Special features

- Separation of two media by just one seal
- Combination of 2 sealing lips in one component
- Very firm and exact fit inside the housing due to metal-metal interference fit
- Be careful when using the product in connection with light metal housings, housings with increased surface roughness and applications with overpressure: Apply sealing aid to the outside diameter if necessary. A version with outside diameter coated with bore sealant is available on request.

## Applications e.g.:

- Separation of two media in rotating machine elements

## Materials

### Standard material

Elastomer	NBR 70 black
Spring	Spring steel according to DIN EN 10270-1
Metal case	Carbon steel according to DIN EN 10139

## Special materials

Elastomer	FKM
	Silicon
	ACM
	HNBR
	CR
	EPDM
Spring	Stainless steel 1.4301
Metal case	Stainless steel 1.4301

## Application parameters

for the standard materials combination

Temperature	-40°C to +100°C
Pressure	depressurized, max. 0.02 MPa
Shaft speed	max. 5 m/s , and acc. to chart „Operating parameters for rotary shaft seals“
Media	Mineral oil based lubricants, synthetic lubricants

When synthetic lubricants are used for which there is no empirical experience, test the compatibility in the laboratory or - better even - in practical trials. The operating temperature should not exceed 80°C.

## Design information

### Shaft

Tolerance	ISO h11
Hardness	min. 45 HRC
Roughness	$R_a = 0.2 - 0.8 \mu\text{m}$ $R_z = 1 - 5 \mu\text{m}$ $R_{\text{max}} \leq 6.3 \mu\text{m}$
Surface finish	free of orientation (lead free)

### Housing bore

Tolerance	ISO H8
Roughness	$R_a = 0.8 - 3,2 \mu\text{m}$ $R_z = 6.3 - 16 \mu\text{m}$ $R_{\text{max}} \leq 16 \mu\text{m}$

## Installation

Please read our installation instructions.

# Installation housings, design

## Design of the shaft

For reliable functioning and long lifespan of the sealing system, the accurate design of the shaft in the contact surface area is decisive. The following data on designing the shaft must be followed implicitly in order to avoid an imbalance of the dynamic sealing mechanism in the contact area between the sealing lip and shaft.

## Tolerance

Shaft diameter tolerance: ISO h11  
Roundness tolerance: IT 8

## Surface roughness

The contact surface area of the shaft should adhere to the following surface parameters:

$R_a = 0.2 - 0.8 \mu\text{m}$   
 $R_z = 1 - 5 \mu\text{m}$   
 $R_{\text{max}} \leq 6.3 \mu\text{m}$

The surface roughness should lie within the stipulated ranges. Shaft surfaces with higher roughness create increased wear on the sealing edge and lead to a decrease in the lifespan.

Better surface roughness than those recommended have the opposite effect and the moisturizing of the shaft surface with lubricant is disrupted. Friction and temperature increase resulting in damage to the sealing edge and the eventual premature breakdown.

## Hardness

The surface hardness of the shaft also has a great influence on the lifespan of the whole sealing system.

Hardness  
min. 45 HRC for normal applications

min. 55 HRC for intrusion of dirt from the outside or polluted media as well as at peripheral speeds > 4m/s

The hardening depth should be at least 0.3mm.  
The grey layer is to be smoothed following nitration.

## Processing procedure

The processing procedure of the shaft surface in the shaft seal area has a great influence on the reliable functioning of the whole sealing system. In particular, achievement of the required "absence of lead" depends on the selection and quality of the processing procedure.

## Lead-free

The contact surface of the shaft must be orientation-free.

In the processing of a shaft surface, the formation of orientation (similar to a micro thread) can ensue which causes a leading effect. Depending on the direction of rotation, this either supports or works against the sealing effect of the shaft seal. In an unfavourable case, if the leading effect of the shaft is higher than that of the shaft seal, leakage can result.

In applications with only one rotational direction, this behaviour can purposely be used to support the sealing effect.

## Plunge grinding

We recommend plunge grinding (without axial feed) as a processing procedure to create a lead free surface. However, some parameters must be observed for plunge grinding to guarantee a lead-free surface.

- The rotational frequency ratio between the grinding wheel and the workpiece must not be an integer.
- An orientation can also be transmitted when the grinding wheel is trued. For this reason, multi-grain dresser tools with as little axial feed as possible or profile truing rolls should be used
- The sparking out time should be set for as long as total sparking out takes

# Installation housings, design

## Hard turning

For economic reasons, more and more surfaces for shaft seals are not plunge-cut ground but done by hard turning. An orientation is created on the shaft surface by the tool feed when turning. This results in a shaft pumping effect when rotating.

For applications with only one rotation direction and concurring directions of the pumping effect of the seal and shaft, the effect is positive and the application of shaft seals is generally not critical in this case.

For shafts with alternating rotation directions, it inevitably counteracts the pumping effect of the seal and the shaft. In order to prevent leakage under these circumstances, the feed effect of the shaft seal must be greater than that of the shaft. The degree to which the individual feed effects and the sum of these is theoretical and cannot be accurately predicted. To prevent leakage under all operating conditions, we strongly recommend that appropriate test runs are carried out.

The feed effect of the seal can be minimized by specific processing parameters. Please contact us for further information.

## Shaft contact surface area

All the demands described for the design of the shaft refer to the shaft surface which means the contact area between the shaft and the seal. The position of the shaft contact surface area for shaft seals with and without protection lip related to the sealing width  $b$  is specified in the following table and figure.

### Contact surface areas for shaft seals acc. to DIN 3760

Sealing width $b$	Contact surface area for			
	shaft seals without protection lip		shaft seals with protection lip	
	$e_1$	$e_2$ min.	$e_3$	$e_4$ min.
7	3.5	6.1	1.5	7.6
8	3.5	6.8	1.5	8.3
10	4.5	8.5	2	10.5
12	5	10	2	12
15	6	12	3	15
20	9	16.5	3	19.5

Contact surface area without protective lip

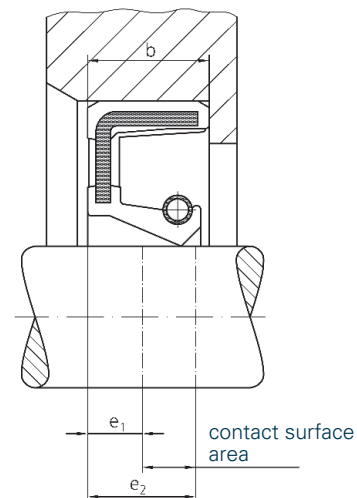

Contact surface area with protective lip

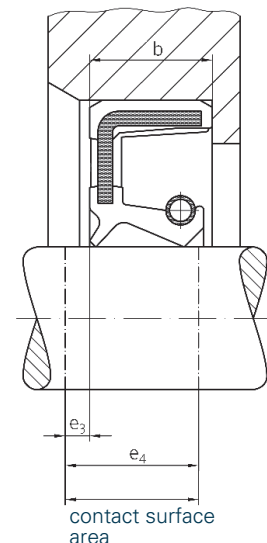

# Installation housings, design

## Offset

If the central axis of the shaft and the housing bore do not exactly correspond, one speaks of offset. The result of offset is an uneven distribution of radial force at the circumference of the shaft. On the one side of the shaft, the contact pressure is maximal which leads to greater wear. On the opposite side, the contact pressure is minimum, which can lead to reduction of the sealing action.

The figure on the right shows the maximum permitted values.

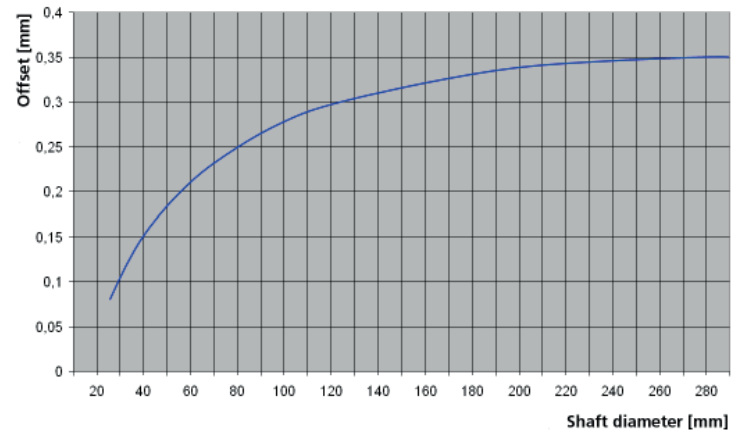

Permissible offset

## Dynamic run-out deviation

Dynamic run-out deviations of the shaft at higher peripheral speeds can lead to leakage. If you observe a point on the sealing edge of a shaft seal, a run-out running shaft underneath makes an up and down movement which the sealing lip, due to its mass inertia, can no longer follow after a specific peripheral speed has been reached. A gap is then created through which the medium can escape as leakage.

The figure shows the maximum permitted values for NBR and FKM (limited values apply for pressurizable types).

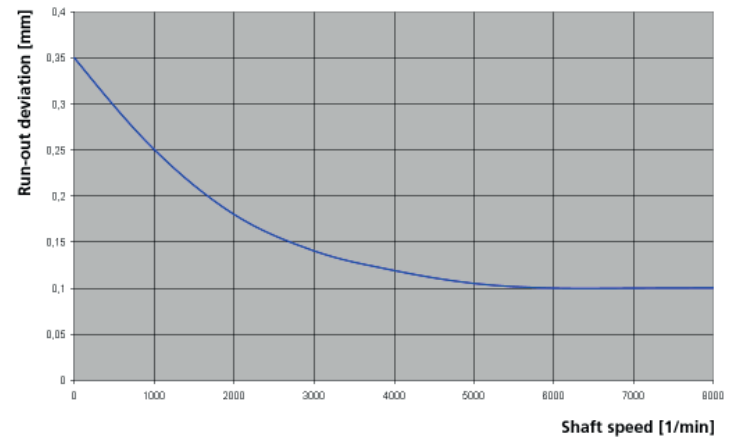

Permissible run-out for NBR and FKM

# Chamfers

## Chamfers

Depending on the installation direction, a chamfer or a radius should be provided. This can prevent damage of the sealing lip on installation.

You will find the angle, radius and diameter in the figure and tables.

### Chamfer diameter

	d <sub>1</sub> [mm]		d <sub>3</sub> [mm]
	to	10	d1 - 1.5
>	10	to 20	d1 - 2.0
>	20	to 30	d1 - 2.5
>	30	to 40	d1 - 3.0
>	40	to 50	d1 - 3.5
>	50	to 70	d1 - 4.0
>	70	to 95	d1 - 4.5
>	95	to 130	d1 - 5.5
>	130	to 240	d1 - 7.0
>	240	to 500	d1 - 11.0

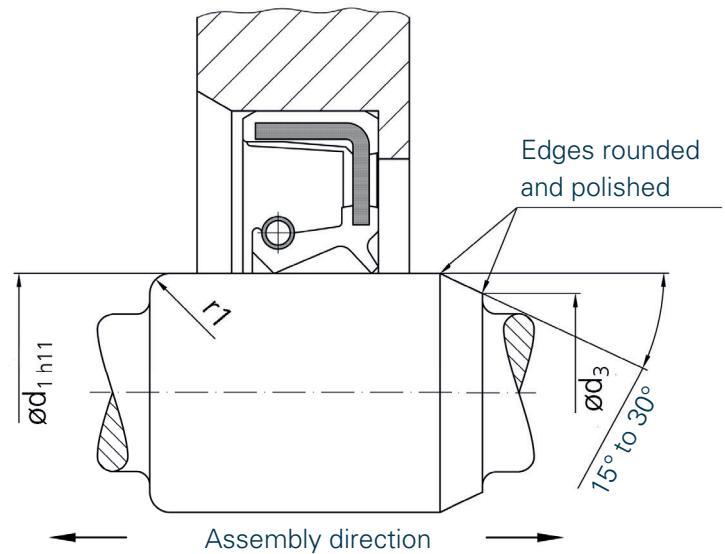

Type	r1 min. [mm]
without protective lip	0.6
with protective lip	1.0

## Protection of the shaft

The shaft surface must be free of all damage in the contact area of the seal. Scratching, scoring, dents or corrosion marks very soon lead to leakage and failure of the seal.

After meticulous processing, it is, therefore, important that appropriate care of the surface is taken during transport and storage of the shaft up to installation. This is facilitated by suitable protective covers and transport containers.

Shaft materials	Application / remarks
Common steels for shafts in mechanical engineering	General
Hardenable stainless steels	Aqueous media Corrosive media
Nonferrous metals	Aqueous media at low peripheral speeds
Casting materials (Fe)	free of shrink holes, fine-pored (<0.05mm)
Hard chromium-plated contact surfaces	Sometimes problematic due to irregular and wear and disruption of the lubricant moisturisation, improvement with plunge grinding finish, if necessary.
Ceramic coating	Very wear resistant but also "aggressive": roughness and pore size to be considered. If necessary, surface must be sealed. Adherence to base material must be guaranteed.
Plastics	Problematic due to poor thermal conduction, so only for very slow movements

# Design of the bore

Apart from the dynamic sealing between the sealing lip and the shaft, a shaft seal also provides static sealing between its outer diameter and the bore. Accurate design of the bore is important to prevent leakage between the outer diameter of the seal and the housing and to guarantee the secure and tight fit of the seal in the housing.

## Tolerance

For the diameter of the bore, the ISO tolerance field H8 is applicable. Specially adjusted tolerances with less interference can become necessary with thin-walled housings and housings made of brittle materials or materials with low strength.

For light metal or plastic housings, we recommend application of types with rubber covered outer diameter as these can better follow the greater thermal expansion of the housing.

## Surface roughness

Type	Permitted surface roughness [ $\mu\text{m}$ ]
according to DIN type A, elastomer outer diameter	$R_a = 1.6 - 6.3$ $R_z = 10 - 20$ $R_{\text{max}} < 25$
according to DIN types B & C, metal outer diameter	$R_a = 0.8 - 3.2$ $R_z = 6.3 - 16$ $R_{\text{max}} < 16$

## Installation depth and chamfers

The depth of the bore is illustrated in the figure and table.

The angle of the lead-in chamfer should be  $15^\circ$  to  $20^\circ$ . The transition between the chamfer and cylindrical surface should be burr-free

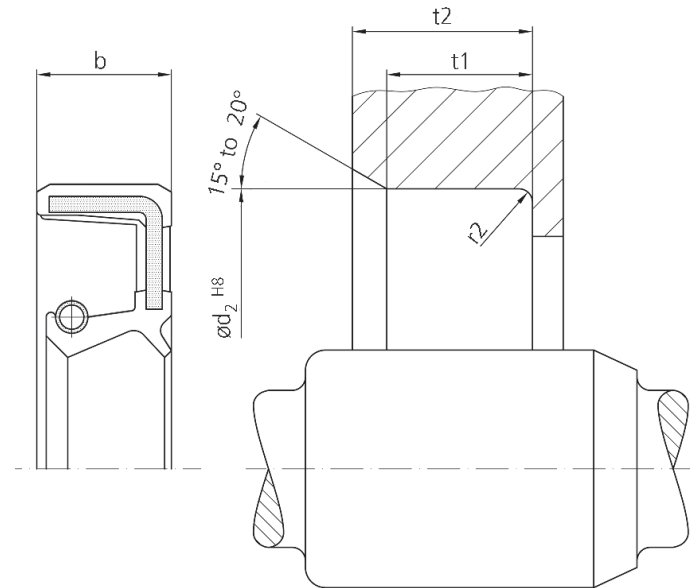

## Dimensions of the bore

b	t1 min. ( $0.85 \times b$ )	t2 min. ( $b + 0.3$ )	r2 max.
7	5.95	7.3	
8	6.8	8.3	0.5
10	8.5	10.3	
12	10.3	12.3	
15	12.75	15.3	0.7
20	17	20.3	

All dimensions in mm

# Installation

The reliable functioning of a shaft seal depends on the correct installation. The seal must be installed without damage and correctly positioned. Experience has shown that approx. 1/3 of the reasons for failure of shaft seals is attributable to incorrect installation.

In normal cases, the shaft seal is installed with the top end (the open side facing the spring) facing the medium to be sealed, or the side facing the pressure.

The following instructions are important for the installation of shaft seals:

- Before the seal is installed, all components should be cleaned from machining residue, e.g., chips and dirt.
- The seal, the shaft and the housing must be lubricated prior to installation (oil, or grease tested for compatibility with sealing material). Apart from facilitating installation, lubrication is also ensured from the first shaft rotation and a dry run is prevented.
- With the installation of types with protective lips, the space between the sealing lip and the protective lip can be "filled" with grease. This should not exceed 50% of the available space.
- The shaft and the installation housing must be provided with chamfers. The detailed design of the chamfers can be found in "Installation housings, design".
- Sharp edges should carefully be removed or - better even - avoided by the designer by providing suitable chamfers or radii.
- Seals should in no case be pulled over sharp edges. Thread, key grooves, boreholes, etc. should be covered during installation.
- For faultless installation, we recommend using a mechanical or hydraulic press-fitting device with the appropriate press-in tool.
- The press-in force should be exerted as closely to the outer diameter as possible.
- The seal must not be pressed-in at a skew and must rest at right angles to the shaft.
- Should it be necessary to use a hammer for installation, it is essential to place a full surface safety plate over the seal. The seal should not be directly hit by the hammer. Deformation and skewing of the seal must be prevented.

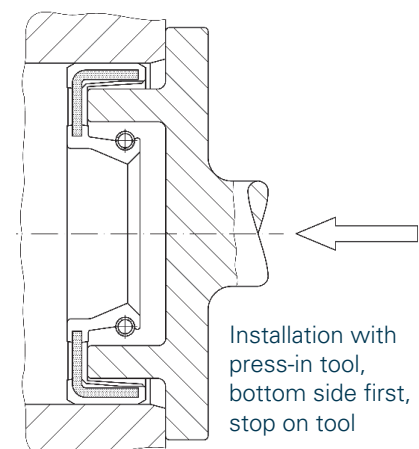
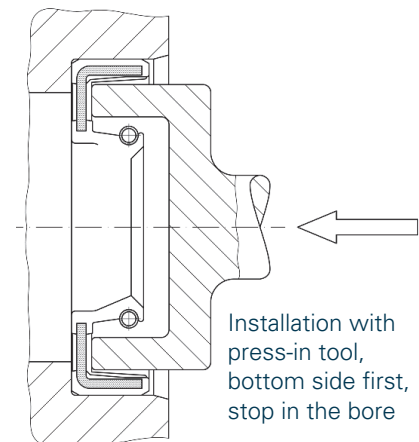
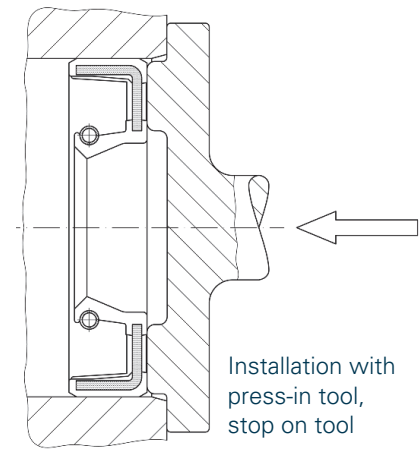
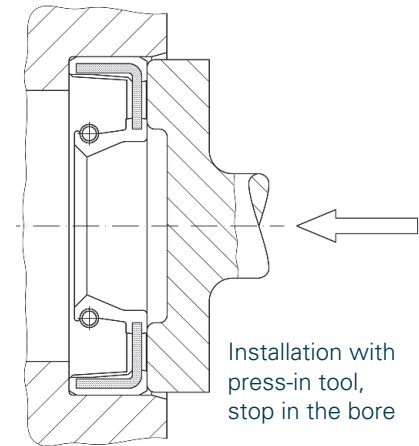

# Installation

- Should the design provide for e.g. the bearing and the contact surface of the seal having the same nominal diameter, when the bearing is installed, the contact surface could be damaged by axial scratching. In this case, the shaft diameter in the area of the contact surface should be designed to be approx. 0.2 mm smaller.
- Particular care must be taken with the installation of shaft seals with PTFE sealing lips (e.g. our types OS-PA30 to OS-PA32). If the shaft seal is installed with the front side first, we recommend the use of an installation cone with an angle of 10 - 20°. If the installation is done with the bottom side first, the shaft should be provided with a radius of  $R_{min} = 1\text{mm}$ .

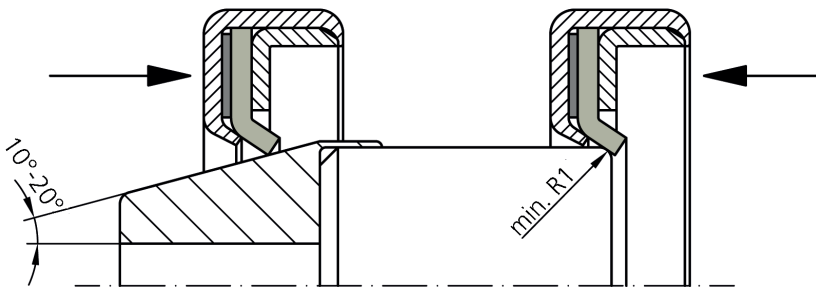

## Replacement of shaft seals

When servicing or repairing a machine, the used shaft seals should always be replaced by new ones. Care must be taken that the new seal does not run in exactly the same track on the shaft as the old one. The new shaft seal can e.g. with the use of a spacer ring, be pressed into the bore at a different depth (see figure on the right). If a shaft sleeve is used, this should also be replaced, if necessary.

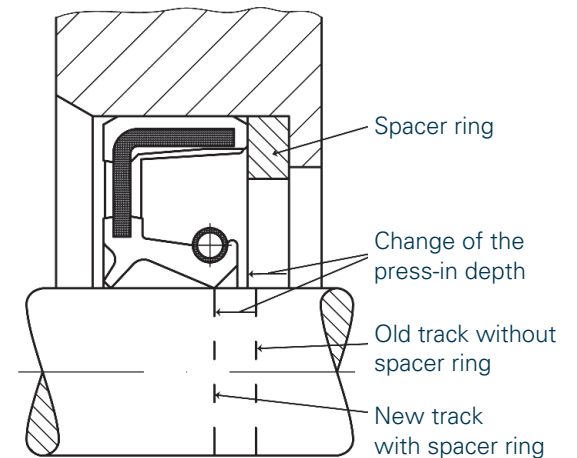

# Operating parameters

## Peripheral speed (rotational speed)

The figure to the right illustrates the permitted values for rotational speed or peripheral speed of the shaft for shaft seals as a function of material. The diagram is for no-pressure operation and favourable conditions with regard to lubrication and heat dissipation. With less favourable peripheral conditions, the permissible values are reduced correspondingly. For example, for grease lubrication the values can be assumed to be 50% lower.

The application of types with protective lips can cause friction-induced temperature increases. In this case the maximum peripheral speed must also be reduced.

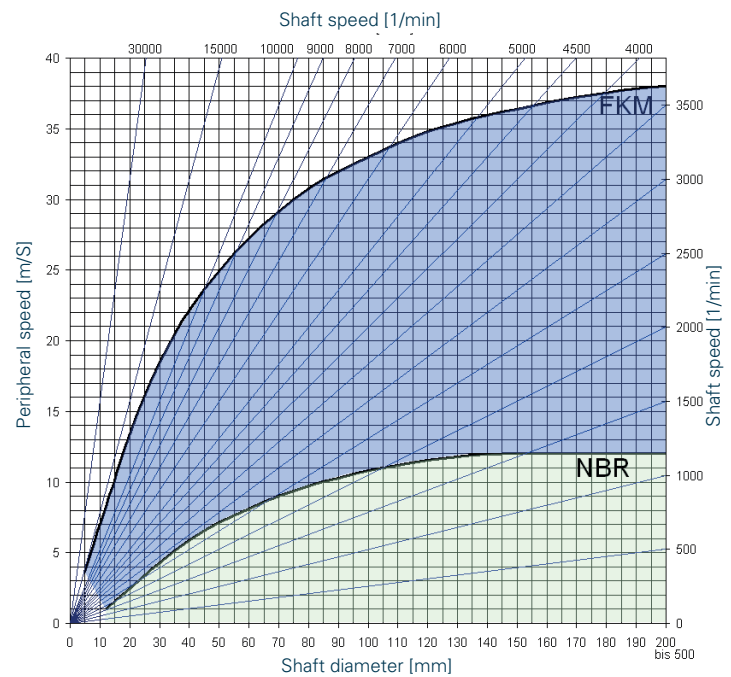

# Operating parameters

## How to use the diagram

### With known shaft diameter and rotational speed:

You have to determine the point of intersection of the vertical line above the corresponding shaft diameter in [mm] at the base of the diagram with the appropriate diagonal rotational speed line starting from the right or upper edge of the diagram.

### With established shaft diameter and peripheral speed:

You have to determine the point of intersection of the vertical line above the corresponding shaft diameter in [mm] at the base of the diagram with the appropriate horizontal line starting from the left edge of the diagram at the corresponding peripheral speed in [m/s].

If this intersection point lies below the NBR curve, a shaft seal in NBR can be used for this application. Should the intersection point lie above the NBR curve but below the FKM curve, a shaft seal made from FKM (VITON® ; Du Pont Dow trade name) can be used. NBR materials would be thermally overtaxed in this area due to the high speed.

In borderline cases all application parameters should be carefully considered and a higher quality material selected, if necessary. Should the resulting intersection point also lie above the FKM line, the application of standard shaft seals can no longer be recommended.

Please do not hesitate to contact us for further information and advice.

## Example:

rotational speed 1500 1/min  
 $\delta$  peripheral speed

$$v [m/s] = \frac{d [mm] * n [1/min] * \pi}{60000}$$

v = peripheral speed  
 d = shaft diameter  
 n = rotational speed

$$\delta \quad v = \frac{100 * 1500 * 3,1416}{60000} \approx 7,9 \text{ m/s}$$

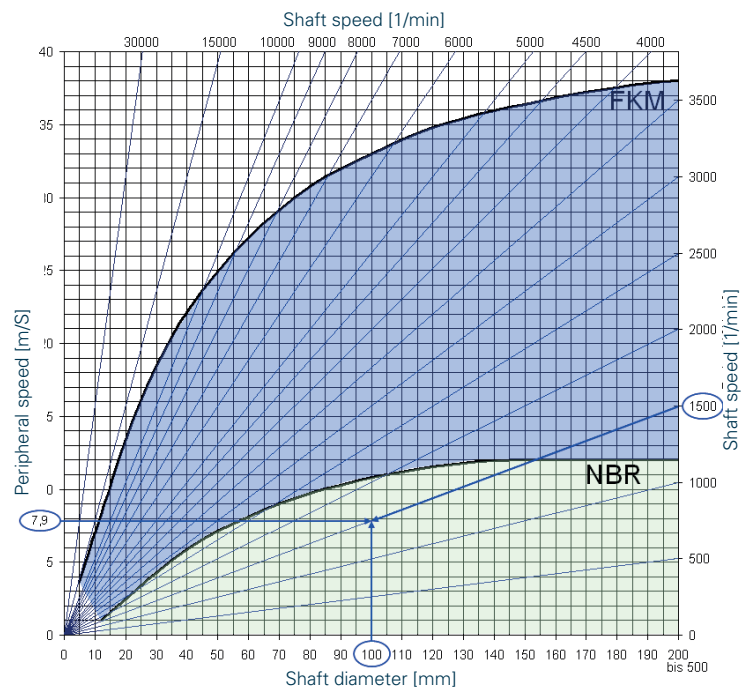

in no-pressure operation

## Result:

The determined intersection point lies within the NBR area. With good lubrication and good heat dissipation a shaft seal made from NBR can be used.

# Temperature

The temperature load to which the seal is subjected consists of the temperature of the medium, e.g. oil temperature and the excess temperature induced by the friction between the sealing edge and the shaft.

The temperature thus created in the sealing gap can reach up to 80°C in excess of the oil sump temperature depending on the peripheral speed, lubrication condition, medium, heat dissipation conditions, material of the shaft seal, surface finish of the shaft and the pressure load. An excess temperature of 30°C - 40°C can even occur in standard practice operational conditions.

The load caused by excess temperature must be considered in the selection of suitable material in accordance with the following table .

<b>Material</b>	<b>Hardness [Shore A]</b>	<b>Colour</b>	<b>High temperature resistance [°C]</b>	<b>Low temperature resistance [°C]</b>
NBR	70	black	+100	-40
FKM	80	brown	+150 continuous +200 max.	-30
HNBR	70	black	+125	-40
VMQ	80	red	+150 continuous +200 max.	-55
ACM	70	black	+150	-20

Should a thermal overload occur, it could result in premature failure of the seal due to excessive wear as well as hardening and cracking of the sealing lip.

# Pressure

All standard shaft seals are designed for non-pressure operation.

Should excess pressure develop within the unit to be sealed during operation, it is advisable to ventilate the housing. Nevertheless, excess pressure of up to 0.05 MPa can be controlled by standard types. The maximum rotational speed is then reduced according to the following table:

Pressure difference maximum [MPa]	Shaft	
	Maximum speeds [1/min]	at maximum peripheral speed [m/s]
0.05	up to 1000	2.8
0.035	up to 2000	3.15
0.02	up to 3000	5.6

Permitted rotational speed with pressurization acc. to DIN 3760

The pressing force of the sealing lip against the shaft increases as a result of the pressure build-up. The sealing lip is deformed and the contact width between the sealing lip and the shaft increases. This results in a sharp increase of the friction and the thermal load. This increased load must be taken into consideration when selecting the type and material of a seal. Premature failure of the seal due to wear or hardening would otherwise be the consequence. If the overload is too high, it can lead to lip inversion (a section of the sealing lip is turning outward towards the air side).

In pressurized systems, there is a danger of the shaft seal being pressed out of its fitting. For this reason, we recommend that axial protection is included in the design, e.g. a flange lid or a circlip.

## Special types are available for sealing with excess pressure:

### Our type OS-N21:

The sealing lip and the reinforcing ring of the OS-N21 are specially designed for pressure applications. The sealing lip is shorter and stiffer and does not allow excess increase of the contact pressure. The reinforcing ring is pulled down lower on the shaft diameter and can better support the sealing lip. The lower flexibility of the sealing lip requires lower tolerances with regard to the dynamic run-out and offset.

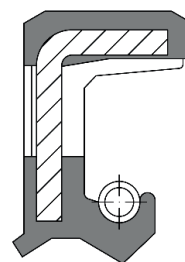

Type OS-N21

The application limits depend on the rotational speed and diameter of the shaft - see table:

Speed [1/min]	Shaft diameter [mm]		
	20	40	80
0	10	8.5	7
500	10	8.5	5
1000	5.5	4.5	3
2000	3	2.5	1.5
3000	2	1.5	0.3
4000	1.2	0.5	0
5000	0.7	0	-
6000	0	-	-

Maximum pressure [bar] for the OS-N21 type. The figures apply for oil lubrication and favourable conditions with regard to heat dissipation.

# Shaft seal + support ring

## Shaft seal + support ring

As an alternative to the OS-N21 type, a standard shaft seal (without protective lip) plus a separate support ring can be used. The permissible pressures for this option are lower than those for the OS-N21. Please contact us for the applicable support ring drawings.

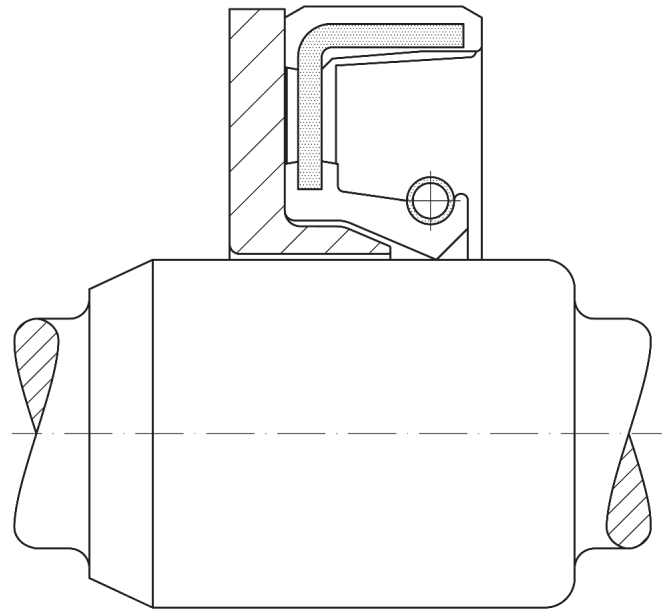

Shaft seal with support ring

For pressures higher than the application limits of the OS-N21 further types are available, e.g. OS-N11. This can be used to seal pressures of up to 5 MPa (at a very low speed, e.g. slow swivelling movements).

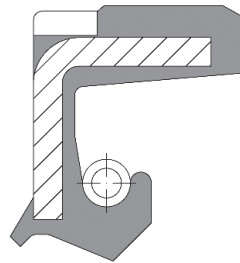

Type OS-N11

# Media to be sealed

The medium to be sealed combined with the expected temperature in the sealing area, has a decisive influence on the selection of the shaft seal and its material.

The shaft seal must be "resistant" to the medium used, which means the chemical influence on the sealing material should not negatively affect its characteristics to a considerable degree.

## Elastomers can

- soften as a result of swelling, whereby the material absorbs some of the medium to be sealed or
- harden as a result of ageing processes, accelerated by high temperatures.

## Evaluation of resistance can result from:

- 1. individual experience gained in comparable applications
- 2. Elastomer resistance lists (contact us, if necessary)
- 3. Information from the media producers (values gained by experience with standard elastomers)
- 4. laboratory tests with evaluation of characteristics of hardness, volume, tensile strength, ultimate elongation after storage of standardized test specimen in the medium
- 5. test rig testing under practical application conditions
- 6. practical tests under real conditions in machinery

In many cases, the evaluation of resistance is sufficiently accurate after the first 3 items. With sensitive applications, unknown media, mixtures of different media and applications in which several parameters reach their permitted limits, resistance should be tested in advance (items 4 to 6).

## Mineral-based lubricants

In the area of low additivated mineral oil based lubricants, our standard shaft seals made from NBR and FKM generally have good resistance. With special highly additivated lubricants, we recommend contact with the lubricant producer and, if necessary, testing.

## Synthetic lubricants

The effect of synthetic lubricants on the sealing material depends mainly on the proportion of additive used in the lubricant. As positive as its effect on the characteristics of the lubricant is, its chemical influence on the seal can be just as negative. For this reason, we recommend testing of resistance where there is doubt.

Generally speaking, application of our standard shaft seals if NBR is possible with compatible, low additivated, synthetic lubricants and temperatures to approx. 60-80°C. At higher temperatures or higher additivated synthetic lubricants, FKM has proven to be the better material choice.

## Aggressive media

Aggressive media require use of correspondingly more resistant sealing material or material combinations. Please consult the relevant resistance lists. The products from our range which are most suitable in this case are:

### OS-F10, OS-F11

Sealing lip material: FKM  
Spring material: Stainless steel 1.4310  
Reinforcing ring: Fully-covered with elastomer (corrosion protected)

### OS-PA30, OS-PA31, OS-PA32

Sealing lip material: PTFE  
Reinforcing ring: Stainless steel 1.4571

### OS-W50

Sealing lip material: PTFE, static sealing by FKM O-ring  
Spring material: Stainless steel 1.4571

# Temperature / Media

Highest permitted continuous temperatures for various media [°C]

Material	Mineral oils									Fire-resistant hydraulic fluids VDMA 24317 DIN 24320			Other media		
	Low temperature	High temperature (in air)	Engine oils	Transmission oils	Hypoid transmission oils	ATF oils	Hydraulic fluids acc. DIN 51524	Fuel oils EL and L	Greases	HFA Öl in Wasser Emulsionen	HFB	HFC	HFD	Water	Suds
NBR	-40	100	100	80	80	100	90	90	90	60	60	60	-	80	80
FKM	-30	200	150	150	140	150	130	100	150	●	●	-	150	80	80
NBR high-temperature grade	-30	120	120	100	100	110	100	90	100	60	60	60	-	80	80
NBR with high ACN content	-30	100	100	80	80	100	90	90	90	60	60	60	-	80	80
NBR low temperature grade	-50	90	90	70	70	80	80	●	80	●	●	●	-	●	●
NBR food grade	-40	100	100	80	80	100	90	90	90	60	60	60	-	80	80
NBR anti-friction	-40	100	100	80	80	100	90	90	90	60	60	60	-	80	80
HNBR	-40	150	110	90	90	110	100	90	100	60	60	60	-	90	90
Silicone VMQ	-55	200	130	130	-	-	-	-	-	●	●	●	-	●	●
ACM	-20	150	125	120	120	120	120	●	120	-	-	-	-	-	-
PTFE	-90	250	150	150	150	150	150	150	150	+	+	+	150	150	+

+ resistant, application not customary

● limited resistance

- not resistant

# Storage of Elastomers

The optimum storage conditions for Elastomer products are described in DIN 7716 and ISO 2230. Adherence to these instructions allows the storage of Elastomers for a period of several years without reduction in quality.

The most harmful factors for accelerated ageing of Elastomers are

- mechanical stress (compression, tension, bending, ...),
- subjection to oxygen,
- ozone,
- light,
- heat,
- humidity
- and solvents.

For this reason, the following basic rules should be observed:

## Warehouse

The warehouse should be cool, dry, dustfree and moderately aired. The relative humidity should not exceed 65%.

There should be no ozone producing electrical equipment set up in the warehouse. The warehouse should also not be simultaneously used for the storage of solvents, fuels, lubricants, chemicals or other gas emitting substances.

## Storage temperature

The temperature should be approx. 15°C although fluctuations from +20°C to -10°C are permissible. Sources of heat e.g. radiators should be at a distance of at least 1m from the goods to avoid direct heat radiation.

## Lighting

Elastomers must be protected from direct sunshine and artificial lighting with a high UV ratio. It is advisable to light the warehouse with conventional bulbs.

## Packaging

Sealed packaging e.g. airtight containers or polyethylene bags protect the goods from the surrounding atmosphere and thereby from oxygen and ozone. Packaging materials may not include softeners or other substances harmful to elastomer.

## Mechanical stress

Elastomer products should be stored stress-free. This means they should not be subjected to tension, compression, bending or any other stress.

## Storage of components

Particular care must be taken in the storage of e.g. screw couplings with external, prefitted seals. The tensile stress of a stretched seal results in severe acceleration of the ageing process. For this reason, the stretching of a seal should be kept to a minimum in the constructive design.

Despite optimum storage conditions, the components should not be stored for long periods and is imperative they are promptly further processed in accordance with the principle of "first-in first-out".

# anyseals - where distributors go

## The anyseals warehouse

has been equipped in accordance with state-of-the-art technology. The fully automatically controlled high rack is completely enclosed. With extreme temperatures in the immediate environment, climate control is activated automatically to ensure that the parts are always stored in compliance with the DIN regulations.

## The individual production batches

are separated so that absolute sorting accuracy and guaranteed traceability of the individual delivery to the production batch is assured. A barcode system eliminates picking errors in type and lot.

## Warehouse availability,

possible delivery time, prices and orders. Shop. anyseals.eu is the quickest connection between customer and seal.

## However much technology,

the **anyseals** team whether in Belgium, Germany, USA or Taiwan, is made up of people who are committed to seals and the technical trade. Every day, we live and breathe our philosophy of close contact with our customers, discussions, advice, negotiation, technical solutions and other helpful measures.

The greatest possible availability of the various standard seals requires substantial warehouse capacity as well as secure and quick picking possibilities.

## Quality assurance

**anyseals** procures seals exclusively from approved and certified production companies (ISO 9001:2015 or IATF 16949). Our own production companies are also appropriately certified.

We have our own laboratory outfitted with the very latest testing equipment for any additional testing required by the anyseals Quality Assurance system.

All our products and materials can be identified and are traceable due to the lot and material number. For each material there is a detailed material data sheet available.

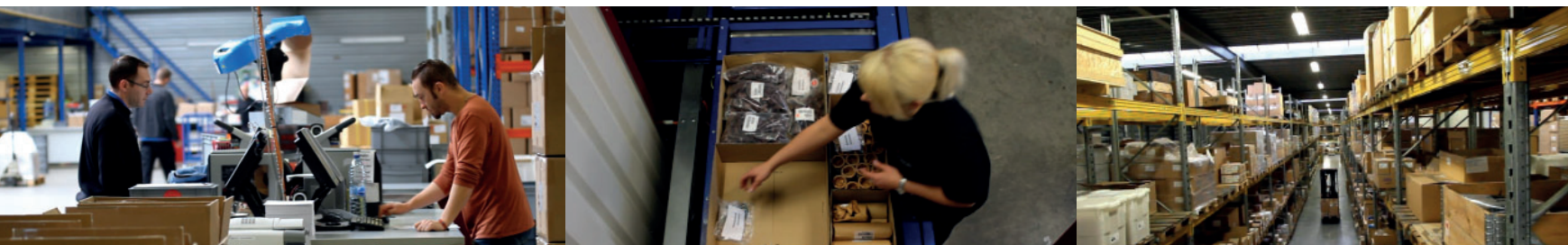

# anyseals - where distributors go

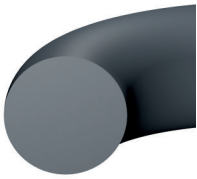

## O-Rings

anyseals offers quality o-rings, expert service, and competitive pricing. AS568 standard, metric, Mil Spec, JIS and FDA O-rings are always available. Stocked materials include Buna NBR, HNBR, FKM, EPDM, PTFE, FEPM, ACM, VMQ, Silicone (SI), and Neoprene (CR).



## Encapsulated O-Rings

Encapsulated O-rings are o-rings consisting of a seamless and uniform PTFE or FEP encapsulation/jacket which completely encloses a core material of either PTFE, VMQ-silicone or FKM elastomers. Call anyseals today for quality encapsulated O-rings!

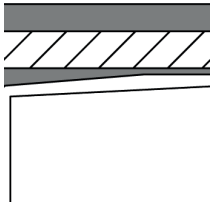

## Oil Seals

Oil seals, also known as lip seals, grease seals and rotary shaft seals are used to seal rotary elements, such as a shaft or rotating bore. Our durable oil seals interchange with all major brands. Common stocked elastomers include NBR, FKM, EPDM, VQM, ACM and HNBR.

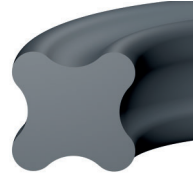

## X-Rings

X-rings have a double sealing function as compared to an O-ring and can be used in a wide variety of static and dynamic sealing applications. X-rings are also designed to outperform a standard O-Ring in rotary seal applications. anyseals offers AS568 and metric sizes in NBR or FKM.

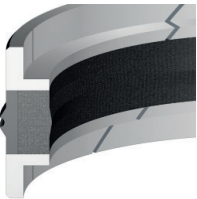

## Piston Seals

Hydraulic Piston Seals or Piston Rings are used in hydraulic cylinders for fluid sealing and are designed to ensure that pressurized fluid does not leak across the cylinder head as the system pressure pushes the piston down the cylinder bore.

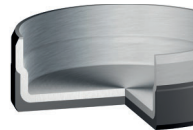

## Cover Seals

Also referred to as service hole plugs or end caps are a rubber-to-metal bonded cap commonly used as a plug or cap on gear boxes. Cover seals are designed to fit directly on housing bores for rotary shaft seals. anyseals offers them in both nitrile and fluorocarbon.

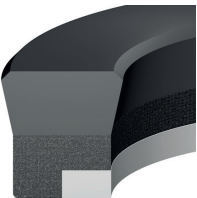

## Rod Seals

The rod seal is designed to ensure that pressurized fluid does not leak out of the system as the rod cycles back and forth out of the gland (dynamic pressure sealing) anyseals offers a wide range of hydraulic rod seals for both single-acting and double-acting systems.

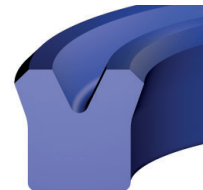

## U-Cups

U-Cups are a lip seal, named for the cross-section's distinctive "U" shape. anyseals offers a wide range of U-Cup designs with a broad range of materials. Loaded U-Cups, non loaded U-Cups, spring energized, single lip U-cups, twin lip U-cups are all in stock and ready to ship.



## Axial Seals

Axial seals also known as Gamma Seals are attached to a rotating shaft for sealing axially against perpendicular faces. They combine the high-speed capacity of standard mechanical seals with the simplicity of radial lip seals. Stocked in both NBR and FKM.

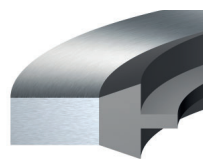

## Bonded Seals

Commonly known as Dowty washers, they are often used as bolt seals in hydraulic equipment. Stock is available in standard, self-centering, BSP and metric sizes. We also offer a full range of metal and rubber specifications in NBR and FKM.



### Square Cut O-Rings

Square rings are available in a variety of rubber and plastic materials such as Buna NBR, FKM, EPDM, VMO, etc. In most static applications, a square ring will serve as a direct replacement for an O-ring and generally will perform better in high pressure sealing functions



### Back-up Rings

Back-up rings are used in conjunction with O-rings for both static and dynamic sealing applications. There are three basic types of back-up rings, single turn (split or scarf-cut), multi-turn (spiral cut), and solid (uncut). Available in PTFE, POM, PEEK, NBR, FKM and AU.



### Hygienic Sanitary Seals

Hygienic seals are used widely in the Biotech, Pharmaceutical, Dairy, Food & Beverage, Industrial and Semi Conductor industries to seal clamp connections in sanitary pipe lines. We offer an extensive range in several compounds according to DIN 11851 and FDA 177.2600.



### Din 3869 Profile Ring Seals

Profile ring seals are manufactured in accordance to DIN 3869, ISO 9974, ISO 11926 and ISO 1179 specs. They are molded parts made of elastomers for sealing threaded tube connections and fittings with threaded elements. Available materials include NBR, FKM and EPDM.



### D-Ring Seals

D-ring seals improve gland stability and eliminate the potential of the seal to roll. D-rings can be either extruded or machined and manufactured in various compounds including Buna NBR, FKM, EPDM and VMO. Hardness ranges are from 60 to 90 Shore A.



### V-Rings

The function of a V-ring is to exclude dirt, water, or other aggressive media from entering bearing housings while also retaining grease. NBR nitrile V-Rings are the most common type, however, anyseals also stocks FKM-fluoroelastomer for higher heat applications.



### Hydraulic Radial Seals (Slipper Seal)

The slipper seal is a radial sealing element that consists of a PTFE carbon/graphite ring and an elastomeric O-Ring energizer. This type of seal is typically selected for general industrial pneumatic/hydraulic applications where there is a need for a dynamic sealing element.



### Rubber Flat Ring Washers & Gaskets

Rubber O-ring flat washers & gaskets are available in various styles and materials. Materials that are offered include; Neoprene Rubber, Silicon, EPDM, NBR, SBR, FKM, VMO and CR. You can also even choose from either lathe cut, stamped, tube cut or molded profiles.



### Wipers

Wipers are installed in the sealing configurations of hydraulic and pneumatic cylinders to prevent contaminants such as dirt, dust and moisture from entering the cylinder as they retract back into the system. Many different materials and styles in stock!



### Rod Seals & Buffer Seals

anyseals can supply both standard and metric piston and rod buffer seals in a wide range of materials and sizes. Buffer seals are usually used in combination with another rod seal, typically a U-cup style seal. Buffer Seals protect the rod seals by reducing pressure peaks.

# anyseals - where distributors go

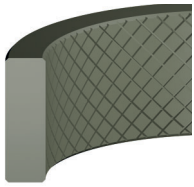

## Guiding Elements

Guide elements perform the task of locating the piston and piston rod in the cylinder, absorbing any side loads that may arise and preventing metallic contact between the sliding parts. We offer a broad spectrum of different materials and designs to adapt to your requirements.

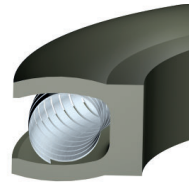

## Spring Energized PTFE Seals

Spring Energized PTFE seals offer extreme-temperature, high-pressure, chemically inert, static and dynamic seals for the most demanding applications. PTFE seals can be used to upgrade existing designs as well as to provide a positive seal for newly designed products.



## Vee Packing

Vee packing, also called v-packing, chevron packing, and parachute packing, is used in Pumps and Valves to seal the fluid or gas being moved. Vee packing can be used for low or high pressure applications and with single or double acting cylinders.

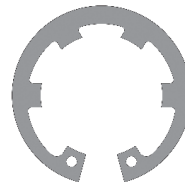

## Circlips & Retaining Rings

Circlip also known as a C-Clip, Seeger ring, or snap ring is a type of fastener or retaining ring consisting of a semi-flexible metal ring with open ends which can be snapped into place, into a machined groove on a dowel pin or other part to permit rotation but to prevent lateral movement.



## Piston Cups

Piston cups are used to provide a pressure and fluid seal on piston heads, pumps, and pneumatic and hydraulic cylinders. They are cup-shaped, with flared lips that contact both sides of the walls of a cylinder, and a hole in the center for fitting over a piston head.



## Shaft Repair Sleeves









Shaft repair sleeves are a solution to overcome problems with worn shafts without having to disassemble the shaft or changing the seal dimensions. Consisting of a thin wall shaft repair sleeve and a simple installation tool, anyseals shaft repair kits can take a worn shaft from scored to restored in a matter of minutes.



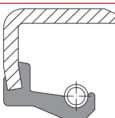
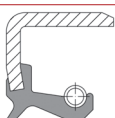
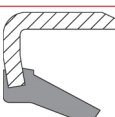

## Custom Molded Products

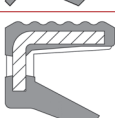
If you require a specialized plastic or rubber part or need priority service for a crucial component that you can't find anywhere else, contact anyseals today and let us help you solve your problem. Our global sourcing network of suppliers means no part or product is ever out of reach, and we can quickly locate and deliver to your business quickly and efficiently.

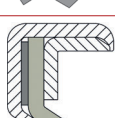
## Oil Seals

Design	anyseals	Simrit	Trelleborg	Forsheda Stefa	Dichtomatik	Taiwan China	Chicago Rawhide CR/SKF	National
	OS-A10	BA	TRA	CB	WA	SC	HMS4	35
	OS-A11	BA SL	TRE	CC	WAS	TC	HMSA7	32
	OS-F10				WA FKM	SF		
	OS-F11				WAS FKM	TF		
	OS-B10	B1	TRC	BB	WB	SB	CRW1	48
	OS-B11	B1 SL	TRD	BC	WBS	TB	CRWA1	47
	OS-B12	B1 OF	"TRG"	"BD"	WBO	VB	HM14	44
	OS-C10	B2	TRB	DB	WC	SA	CRWH1	45
	OS-C11	B2 SL	TRF	DC	WCS	TA	CRWH1	41
	OS-G12		TRK	CD	WAO	VG		
	OS-N21	BABSL	"TRU"		WASY			
	OS-PA31	B2PT						

## V-Rings

Design	anyseals	Simrit	Trelleborg	Forsheda Stefa	Dichtomatik	Taiwan China	Chicago Rawhide CR/SKF	National
 VR-A10			VA	A	VA	VA		
 VR-S10			VS	S	VS	VS		
 VR-L10			VL	L	VL	VL		

## Axial Seals

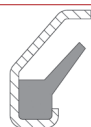
Design	anyseals	Simrit	Trelleborg	Forsheda Stefa	Dichtomatik	Taiwan China	Chicago Rawhide CR/SKF	National
 AS-10		MSC 01	TBP	RB	VRM01	RE		
 AS-11		MSC 02	TBR	9RB	VRM02	RE1		



## Radial Seals

Design	anyseals	Simrit	Trelleborg	Forsheda Stefa	Dichtomatik	Taiwan China	Chicago Rawhide CR/SKF	National
 RD-10		M 15	Roto Glyd Ring® I.D.		RPORI32	VA		
 RD-11		M 16	Roto Glyd Ring® O.D.		RPORA32	VS		
 RD-14		9489	Roto Variseal®		MA47	VL		

## Cover Seals

Design	anyseals	Simrit	Trelleborg	Forsheda Stefa	Dichtomatik	Taiwan China	Chicago Rawhide CR/SKF	National
	CS-10	GA	YJ38	VK	VER	EC		

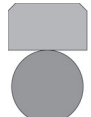
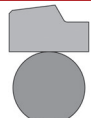

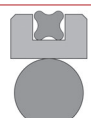
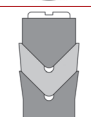
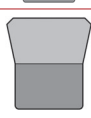
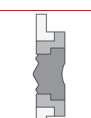
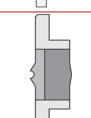
## Piston Seals 1/2

Design	anyseals	Simrit	Trelleborg	Parker	Dichtomatik	Taiwan China	Chicago Rawhide CR/SKF	National
	PS-10	OMK-MR	Glyd Ring®	OE	KPOR30			
	PS-11	OMK-E	Stepseal® K	OG	KPOR31			
	PS-12	TRMA		OA	KO4			
	PS-13		DOUBLE DELTA®	CP	K23			
	PS-19		AQ-Seal®					
	PS-20	EK	CH/G1	M4	KDS01			
	RP-30	S8	Balsele B		KN05 KN06			
	PS-40	L43	DAS DBM	ZX	KK03			
	PS-44	Simko 320 X2	DPS		KK22			

## Piston Seals 2/2

Design	anyseals	Simrit	Trelleborg	Parker	Dichtomatik	Taiwan China	Chicago Rawhide CR/SKF	National
	PS-50	TDUO TDUOH			K15 K17			
	PS-51	TDUO P	AK	DK	K18			
	PS-72	NA300	PUA	B7	KNA28 KNA23			
	RP-70	AUN 100 N 100		GD	KN25 EL2001			
	PS-87	FOA	Variseal® M	JK	KNA44			
	PS-89		Variseal® H	NAA				

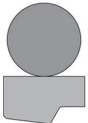



## Rod Seals

Design	anyseals	Simrit	Trelleborg	Parker	Dichtomatik	Taiwan China	Chicago Rawhide CR/SKF	National
	RS-10		Glyd Ring®	ON	SPOR30			
	RS-11	OMS-MR	Stepseal® K	OD	SPOR31			
	RS-12	TFMI			S06			
	RS-13		DOUBLE DELTA®	CR	S23			
	RS-20	ES	CH/G5	M2	SDS01 3/2			
	RP-30	S8	Balsele B		KN05 SN05			
	RS-31		Balsele B/NEI		SNI07			
	RS-72	T20 "NI300"	RUO	B3	SNI30 SNI24			
	RP-70	AUN 100 N 100		GD	SN25 SN21			
	RS-87	FOI	Variseal® M	JS	SNI43			
	RS-89		Variseal® H	NAA				

## Wipers

Design	anyseals	Simrit	Trelleborg	Parker	Dichtomatik	Taiwan China	Chicago Rawhide CR/SKF	National
	WS-10	P6 PU6 AUASOB	WRM	A5	AE40 AE42			
	WS-11	ASOB	ASW	A1	AE41 AE47			
	WS-D14	P8	DA17		AD51			
	WS-D15	P9 PU11	DA22	AY	AD53 AD48			
	WS-20	AS	WSA	AM	AM43			
	WS-21	P7 PU7			AM45			
	WS-22	AUAS	WRM/PC		AM44			
	WS-23	AUPS	SWP	"AF"	AM54			
	WS-D24				ADM55			
	WS-30		Excluder®	AT	A80			
	WS-D31		Excluder® 2	AD	AD60			
	WS-D32		Excluder® 5		AD61			

## Guiding elements

Design	anyseals	Simrit	Trelleborg	Parker	Dichtomatik	Taiwan China	Chicago Rawhide CR/SKF	National
	GS-10	KF SF	Slydring®	F3	FB01 FB05			
	GS-11	KF SF	Slydring®	F3	FB01 FB05			
	GR-P10	FRA KB	Slydring®	FP FR	FRK01 FRK05			
	GR-R10	FRI SB	Slydring®	FP FR	FRS01 FRS05 FRS06			

## Bonded Seals

Design	anyseals	Simrit	Trelleborg	Parker	Dichtomatik	Taiwan China	Chicago Rawhide CR/SKF	National
	BS-10	Usit-Ring U	U-Seal GM500		US			
	BS-11	Usit-Ring USF	GM500 selbstz.		USS			

## Flange Seals

Design	anyseals	Simrit	Trelleborg	Parker	Dichtomatik	Taiwan China	Chicago Rawhide CR/SKF	National
	FS-10			JG	MA45			
	FS-11			JF	MA46			



**anyseals, inc.**

anyseals USA  
10391 Brecksville Road  
Brecksville, Ohio 44141, USA  
T +1 216 676 - 99 34  
F +1 216 676 - 99 35  
mail@anyseals.com  
www.anyseals.com

**anyseals NV**

Preenakker 2-4  
1785 Merchtem  
Belgium  
T +32 (0) 52 - 38 19-20  
mail@anyseals.eu  
www.anyseals.eu

**anyseals NV**

Office Germany  
Hagenau 1  
D-22089 Hamburg  
T +49 (0) 40-25 32 92 -11  
mail@anyseals.eu  
www.anyseals.eu

**anyseals NV**

Office Taiwan  
12F-2, 31 Shizheng North 1st Rd.  
Xi-Tun Dist. Taichung 40756  
Taiwan  
T +886 4 22515813  
M +886 933 580148  
info@anyseals.tw  
www.anyseals.tw

**where distributors go**